

Máquina de Bordado Computarizada

BUTTERFLY Computerized Embroidery Machine

BUTTERFLY SINGLE HEAD 15 NEEDLES BT1501
(General Part)



MANUAL DE USUARIO

OWNER'S MANUAL



Table of Content

Chapter 1 General Information	1
1.1 Warnings and Cautions	1
1.2 Main Features	3
1.3 Technical Specifications	6
Chapter 2 Embroidery Guide	7
2.1 Structure and Usage Instruction of Control Panel	7
2.2 Instruction of Control Panel.....	8
2.3 Instruction of the Main Interface	10
2.4 Notes on Menu Status	19
2.5 Basic Procedure of Embroidery	19
2.6 Normal Embroidery, Returning and Patching	30
2.7 Relations among Normal Embroidery, Idling and Positioned Idling	31
2.8 Embroidery Operation	31
2.9 Thread-Breakage Detection	32
2.10 Working Status of Embroidery Machine	32
Chapter 3 Disk Management	34
3.1 Select Disk	34
3.2 Select One or Several Designs.....	39
3.3 Design Preview	41
3.4 Design Input.....	42
3.5 Design Output.....	44
3.6 Inventory Operation.....	46



3.7 Format Disk	47
3.8 Deleting Objects in Disk (Including Designs and Inventories)	48
3.9 Create a New Inventory in the Current Inventory	49
Chapter 4 Common Parameters and Color-Changing Order	51
4.1 Setting of Common Parameters	51
4.1.1. Setting X-Y Scales	52
4.1.2. Rotate	53
4.1.3. Direction	53
4.1.4. Prior Mode	54
4.1.5. Rep. Mode	54
4.1.6. Rep. Prior	54
4.1.7. X-Y Reps.....	54
4.1.8. X-Y Interval	54
4.2 Setting of Color-Changing Order	55
4.2.1. Color-Changing Interface.....	55
4.2.2. Setting of Color-Changing Order.....	57
4.2.3. Set Needle Color	58
4.2.4. Interchange of Needle Colors.....	59
Chapter 5 Setting of Embroidery Parameters	60
5.1 Procedure for Setting General Parameters.....	62
5.2 Instruction of Some Functions within General Parameters	63
5.2.1. Cyclic Embroidery Function	63
5.2.2. Memory of Manual Color-changing	64
5.2.3. Brake Adjustment (A Must for New Machine)	64



5.2.4. Forbid Design Output	64
Chapter 6 Memory Design Management.....	65
6.1 Memory Design Management Interface and Other Memory Design Operation Interfaces	
65	
6.2 Select a Design to Embroider	67
6.3 Memory Design Preview	68
6.4 Arrange the Memory Design	70
6.5 Copy the Memory Design.....	71
6.6 Compile Parameter Design	73
6.7 Add Appliqué.....	74
6.8 Make True Design Frame	77
6.9 Combine Design	77
6.10 Edit Combined Design.....	79
6.11 Compile Combined Design.....	82
6.12 Satin Stitch Adjustment	83
6.13 High-Speed Design.....	84
6.14 Set Common Parameters for Color-changing.....	85
6.15 Delete Memory Design.....	86
6.16 Move Frame to Make a New Design.....	87
6.17 Divide Design	89
6.18 Clear all Memory Designs	90
Chapter 7 Memory Design Edition	92
7.1 Start Design Edition.....	92
7.2 Edit Design	93



7.2.1. General Information.....	93
7.2.2. Document and View Operation Area	94
7.2.3. Locating Stitch	94
7.2.4. Convert Stitch Code.....	95
7.2.5. Insert Stitch	95
7.2.6. Delete Stitch.....	95
7.2.7. Move Stitch.....	95
7.2.8. Add Stitch Continuously	96
Chapter 8 Letter Design Operation	97
8.1 Generate Letter Design.....	97
8.2 Input Embroidered Letter String and Basic Parameters	97
8.3 Adjust Letter Design.....	99
8.4 Save Letter Design.....	104
Chapter 9 Assistant Operation	107
9.1 Save Design Start Point	108
9.2 Restore Design Start Point.....	108
9.3 Locate Design to Center	109
9.4 Check Border Information of Current Design.....	109
9.5 Move Frame along Design Border	110
9.6 Embroider along Design Border.....	110
9.7 Embroider Cross	111
9.8 Embroider Line.....	112
9.9 Embroider Design Outline.....	114
9.10 Set Offset Point.....	114



9.11 Needle Down	115
9.12 Reset X/Y Displacement.....	116
9.13 Reset Total Stitch	117
9.14 Positioning Idling.....	117
9.14.1. Forward Idling	117
9.14.2. Backward Idling.....	118
9.14.3. Go to Next Color.....	118
9.15 Cording Embroidery	119
Chapter 10 Other Functions	120
10.1 Check Emb Related Parameters.....	120
10.2 View Statistics Info	121
10.3 Set Frame Origin/ Power-off Protection	122
10.4 Frame Origin Recovery	123
10.5 Set Frame Soft Protection	123
10.6 Change Language	124
10.7 Machine Authorization Management	125
10.7.1. Disable/Change Admin Password.....	126
10.7.2. Admin Unlock.....	127
10.7.3. Save/Recover Admin Optimum Parameters.....	128
10.7.4. Change Factory Password.....	133
10.7.5. Factory Unlock.....	133
10.7.6. Save/Recover Factory Optimum Parameters	133
10.7.7. Initialize Machine Parameters.....	139
10.8 Machine Information	140



10.9 Debugging Machine	141
10.10 Date and Time.....	142
10.11 Touching Panel Correction	142
Chapter 11 About JF Sequin Embroidery	144
11.1 Brief of Sequin Embroidery.....	144
11.2 Embroidery Procedure of Sequin.....	145
11.3 Input Sequin Design	145
11.4 Edit Sequin Design	146
11.5 Setting of Multi-Sequin Embroidery Parameters	153
11.6 Change Color Order and Set Sequin Mode	155
11.7 Manual Operation of Sequin Embroidery.....	159
11.8 Debugging Multi-Sequin Embroidery	160
11.9 Sequin Mending.....	162
Chapter 12 Operation of Zigzag Embroidery.....	163
12.1 Functions	163
12.2 Key Technical Indexes.....	163
12.3 Procedure of Zigzag Embroidery	163
12.4 Related Parameter and Setting Mode	163
12.5 Relative Operations of Zigzag Embroidery	165
12.5.1. Shift between Flat Embroidery Position and Zigzag Embroidery Position.....	165
12.5.2. M Axis Operation of Zigzag Embroidery	168
Chapter 13 Online Update of Main Software	169
13.1 Update of Upper Machine	169



13.2 Update of Turn-on Interface173

13.3 LCD Parameter Update.....177

Chapter 14 Update of Software in Peripheral Board..... 183

Appendix 1 Parameter List 187

Appendix 2 Directions of U Disk Operation..... 195

Appendix 3 Error List 196

Appendix 4 Method for Making Special Multi-sequin Design 200

Appendix 5 Network Function of Embroidery Machine 210

Appendix 6 Automatic Limits Function..... 216

All rights reserved. Beijing DAHAO Technology Corp., Ltd.



Chapter 1 General Information

Thank you for using Dahao Computerized Control System for Embroidery Machine.

Please read this manual carefully so as to operate the machine correctly and effectively.

Besides that, you should keep this manual properly for future use.

1.1 Warnings and Cautions

In order to avoid fire, electrical shock or unpredicted injuries, you should follow the listed safety rules.

Matters for Attention on Usage	
⚠ Danger	During the operation, do not try to open the machine box. The high voltage contained in some parts is deadly. The rotating parts may cause serious injury.
⊘ Forbidden	Don't expose the machine to humidity gas, poisonous gas, water, and dust.
⊘ Forbidden	Don't store or operate the machine in the vibration area, which may cause trouble to the machine.
⚠ Attention	Please abide all the warnings and safety requirements to ensure the security.
⚠ Attention	LCD screen is fragile. Do not use the hard or sharp item to click the screen.
⚠ Attention	Pay attention to the direction for inserting the U disk and floppy disk. When the indicator of the disk driver is on, please not to plug in or pull out the disk.
⚠ Attention	We will add appendix if necessary. If there is any difference between the manual and appendix, the content in the appendix shall take precedence.
Matters for Attention on Transportation and Loading	
⚠ Attention	When moving the machine, please not to hold the cable.
⚠ Attention	Please abide all the warnings and safety requirements to ensure the security.
⚠ Compulsory Requirements	Overloading may cause serious loss. Please load according to the instruction on the box
Matters for Attention on Installation	



⚠ Attention	Don't jam the vent on the device. Don't insert other items into the machine, or it may get fire.
⚠ Attention	Make sure the installation direction is correct.
⚠ Attention	Don't expose the machine to humidity gas, corrosive gas, water, and other flammable material.
Matters for Attention on Cable Connection	
⊘ Forbidden	Don't test the insulation of the circuit loop.
⊘ Forbidden	Never try to connect the overloaded electronic device on the connectors (like sockets or terminals).
⚠ Attention	The insulation condition of each cable (no matter signal cable or power cable) should be ensured.
⚠ Attention	The signal cables and power cables should be separated. Never tie them together.
⚠ Attention	All the cables should be well fixed. Don't put any strength on cables. Make sure each turning point of cable is well protected. Add shelter pipes to increase insulating capability if necessary.
⚠ Attention	Machine should be grounded reliably. The resistance should be smaller than 10 Ω .
Matters for Attention on Operation	
⚠ Danger	Don't operate the machine when there is any damage on the shelter of the running parts.
⊘ Forbidden	When machine is running, do not touch any running part.
⚠ Attention	Make sure the configuration of power supply is in normal. Use stabilized voltage power supply when the change of voltage is beyond the range of -10%~10%.
⚠ Attention	In case of warning, please check out the problem. Operation can only be carried out again when problem is solved.
⚠ Attention	The power supply switch has over-current protection function. If the over-current switch is activated, the switch can only be closed after 3 minutes.
Matters for Attention on Maintenance and Inspection	



⚠ Warning	If you need to open the machine cover, please cut off the power supply at first. Due to the capacitance, operator must wait at least one minute before opening the machine cover.
⚠ Attention	Circuit boards can be damaged by static. The circuit boards can only be disassembled by professional technicians.
⚠ Attention	If machine is inactive for a while temporarily, users must power on the machine regularly (once by every 2 or 3 days, more than an hour for each time).
⚠ Attention	If machine is inactive for a long time, users should have the machine checked before power-on.
Matters for Attention on Rejection	
⚠ Attention	Rejection should obey the rules and regulations set by national industrial electronic standards.

1.2 Main Features

1、 User-friendly Interface on Touching Panel

The adoption of the touching panel technology offers user the delightful operation and easy learning. The beautiful screen display turns everyday work into joyful experiences.

2、 Automatic Turn-off of LCD Displayer

In order to extend the LCD life, the system will turn off the LCD automatically in case of no operation in 10 minutes (the time can be changed in parameter setting). Touching the screen or the task-shifting key will reboot the LCD.

3、 Huge Memory Capacity

The memory capacity reaches 16 million stitches, in which 400 designs can be restored. Its huge memory capacity can meet demands of different customers.

4、 Stitch Amount of One Design at One Million Stitches as Maximum

At present a single design in the system has the maximum of 100,000,000 stitches and 250 times of automatic color changing.

5、 Multi-Task Parallel and Free Shift among Tasks

During the embroidery, actions like design input & output, preparation for the following designs and modification of parameters can be carried out. The flexible shift among current tasks can be realized with the task-shifting key.



6、 Storage of Frequently Used Parameters and Color-Changing Order for Each Design

Design will be saved along with its parameters, color-changing orders and needle bar colors. System can save the operational details for each design. Users can set parameters for a design during the embroidery process of the previous design, which will save time and improve efficiency. Moreover, it is one basis to realize network management.

7、 Group Management of Parameters

Parameters can be divided into several groups according to their functions, and the part of parameters can be stored, recovered. In some machine with setting password-protected function, system can set password on the parameters for protection.

8、 Design I/O via USB

Beside to the floppy disk of DOS, FDR and ZSK format, customers can also use USB disk for data transfer. USB disk supports DIR operation, which is easy for design management. For each directory, system supports operation on 400 designs or sub-directory. There is no limitation between directory levels. Designs in the formats of Binary, Ternary and Z-nary can be loaded.

9、 Input of Several Design Files at One Time

Both floppy and USB disks support multi-design input under one directory.

10、 Design Input through Network, Color-changing Order, etc.

Network connector is available, which helps user to input design, color-changing order, and patch sewing and so on.

11、 Network Function

A surveillance LAN can be built by using the connectors and linked to the factory LAN, which realizes network management, improves production efficiency and reduces possible mistakes. It's the best choice of embroidery equipment for enterprises to take the modern enterprise management. The explanation is at appendix V.

12、 Patch Embroidery

This function can set a patch point at the position of color code or stop code, and when the machine embroiders to the patch point, it will halt and move out frame for patching. After sticking a patch, user would press the start key to let the frame return and continue embroidering.



13、 Brake Adjustment

User can adjust the parameter of brake to let the main shaft stop at the correct position according to the characters of his own machines.

14、 Save Start Point

This function can save the start point of each design, which waives the works of user for searching the start point at embroidering the identical design.

15、 Mechanical Maintaining and Debugging

This function is to easily judge the malfunctions at maintaining and testing, such as encoder testing, main shaft speed testing, machine parts testing and the main shaft stopping at any position, etc.

16、 Multi-Language Support

Currently, the system supports the display in Chinese, English, Spanish and Turkish, Russian, French and Portuguese.

17、 Design Output

Design can be output and saved into floppy disk or USB disk. Adoption of TAJIMA's binary system enjoys the advantage of data transmitting through the World Wide Web (other formats may not be transmitted directly).

18、 Repetition Embroidery

The user can increase embroidery productivity by using the function of repetition embroidery, which can also be used with cyclic embroidery.

19、 Cyclic Embroidery

With this function, the machine can automatically return to the origin point and start the same embroidery again when finishing the design one time. The user also can increase embroidery productivity rapidly by combining this function with the special design-making function or repetition embroidery function.

20、 Design Compiling

(1) Compiling the Data of Selected Design to Generate New Design

Users can compile any design according to zoom ratio, rotate angle, normal repetition or partial repetition to generate a new design and save it in the memory card. The newly generated design can be used for embroidering, output or other operations.

(2) Compiling the Combined Design



After setting the combined design, the system can compile that design to generate a new one and save it to the memory card. The newly generated design can be used for embroidering, output or other operations.

21、 Letter Design

There are 28 letter-bases altogether. Users can make groups and change the letter order according to different tasks. This operation is simple and easy managing.

22、 Design Editing

By using this function, users may insert, modify or delete certain stitch at the selected point. New designs can be created with this function too.

23、 Speed Adjustment

The highest speed for embroidery can be preset. During the process of embroidery, speed changes automatically as long as the needle interval changes.

24、 Thread-trimming

Thread-trimming can be manually controlled. The machine can trim the thread automatically at the end of embroidery process or color-changing.

25、 Thread-breakage Detection

In case of thread breakage or running-out of bottom thread, the machine will stop and give the warning by blinking the indicator.

26、 Color-changing

At the color changing point, user can either perform the color-changing manually or let the system do it according to the preset order automatically.

27、 Cording Embroidery

The cording embroidery enriches the type of the embroidery of the system.

1.3 Technical Specifications

- 1、 Maximum number of designs saved into memory: 400
- 2、 Memory capacity: 16 million stitches
- 3、 Resolution: 800*480
- 4、 Network port speed: 10Mbps
- 5、 Supported method for data exchange: Floppy disk, USB Disk and network
- 6、 Control precision: Minimum controllable stitch interval is 0.1mm.
- 7、 Stitch range: 0.1mm~12.7mm

Chapter 2 Embroidery Guide

2.1 Structure and Usage Instruction of Control Panel

I. Structure of Control Panel



1、Touching Panel

It adopts high-luminance LCD displayer and touching screen man-machine interaction interface.

2、Buttons

Common actions can be realized with the buttons on the control panel. Those actions include: frame-moving speed shift, frame-moving, manual color-changing and Multi-task shift.

3、Main USB Port

USB disk can be plugged for data input/output.

4、Emergency Stop Button

This machine has the emergency stop button, which is to cut off the power on the control circuit in hardware on one hand and to realize the linked protection in software on the other hand.

II. Instruction of Touching Panel

This machine uses the touching panel as its input device. In order to extend the service



life of the panel and to maintain its performance, please don't apply too much pressure on the screen during operation. Neither can user use the sharp or hard tools to click the screen.

III. Instruction of Floppy Disk

The floppy driver of this computer is the external attached device, which is connected to the operation panel with the USB port. Please pay attention to the direction for plugging. Do not apply force when the plug-in direction is wrong, or it may destroy the floppy driver and the floppy disk itself.

IV. Instruction of USB Disk

Please pay close attention to electrostatic phenomenon. Don't forget to discharge (we suggest you should touch the machine stand or frame to discharge the static) before plugging in/out the USB disk.

Pay attention to the direction of the USB disk at plug-in. Don't pull out the USB disk when system loads data from or write data to it. If the USB disk is pulled out or the power is cut off during the data input/output, the data could be lost. In that case, please check the integrity of data in the USB disk and repair it before using.

Attention: During the process of initialization, if the power is cut off or the USB disk is pulled out, the USB disk may be damaged permanently.



V. Instruction of Network Connection

Please preset the network parameters before the connection, or it may cause the failure of communication within the network.

2.2 Instruction of Control Panel

The operation can become much easier by using the hotkeys and the touching screen. Meanwhile, the statuses of the hotkeys are displayed on the main interface correspondingly:







Number	Name	Description
1	Low Needle Position Color-changing	Press this key, the current needle position will not move towards to the low needle position until it reaches the first needle position.
2	High Needle Position Color-changing	Press this key, the current needle position will not move towards to the high needle position until it reaches the highest needle position.
3	Task Shift	If user opens several interfaces, he can use this key to shift among these interfaces.
4	Cruise the Border	Press the key, the icon will move along with the border of the design.
5 6 7 9	Manual Frame-moving	During the operation, the frame moves in the direction as same as the figure on the direction keys. The combined direction is supported.
8	Speed Shift of Manual Frame-moving	Press this key to switch the frame-moving speed between  (High) and  (Low).
10	Stop Key	Press it to pause the embroidery.
11	Start Key	Press it to start the embroidery.

2.3 Instruction of the Main Interface

Note: in the following charts, the icons with  are the touchable keys; those without that figures are for the machine status.











No.	Display	Name	Description	Reference Page
1		Embroidery Ready Status Confirm the Embroidery 	The machine is in the Ready Status, and user can carry out preparation works of the embroidery, such as design selection, setting scale parameter, setting repetition parameters and so on. Click that key and confirm, the machine will turn to Embroidery Confirmation Status  from Embroidery Ready Status  .	Chapter 2.5













No.	Display	Name	Description	Reference Page
		Embroidery Confirmation Status Cancel the Embroidery	Currently, machine is at the Embroidery Confirmation Status, and user can start embroidery at any time. When the machine stops, user can click that key and confirm the operation for cancelling the Embroidery Confirmation Status. And the Machine will return to Embroidery Ready Status from Embroidery Confirmation Status .	Chapter 2.5
2		Normal Embroidery	The machine is currently in normal embroidery status. When user presses the start key for normal embroidery, the main shaft rotates, the frame moves along the stitch trace and threads shape the design on the embroidery materials. When user presses the stop key for returning, the machine returns in low-speed idling. When the machine stops, click this key to switch to the low-speed idling	Chapter 2.5
		Low-speed Idling	The machine is currently in low-speed idling status. When user presses the start key for normal embroidery, the main shaft remains inactive and the frame advances along the stitch trace. When user presses the stop key for returning, the main shaft remains inactive and the frame returns along the stitch trace. When the machine stops, click this key to switch to high-speed	Chapter 2.5



No.	Display	Name	Description	Reference Page
			idling status 	
		High-speed Idling 	<p>The machine is currently in high-speed idling status. When user presses the start key for normal embroidery, the main shaft and the frame remain inactive while the count of stitches increases. When user presses the stop key, the frame directly moves to the actual position of the current stitch count. When the machine stops, click this key to switch to the normal embroidery status</p> <p>When user presses the stop key for returning, the main shaft and the frame remain inactive, while the count of stitch decreases. When user presses the stop key, the frame directly moves to the actual position of the current stitch count.</p> <p>When the machine stops, click this key to switch to the normal embroidery status .</p>	Chapter 2.5
3		Manual Color-changing Manual Start 	<p>In this status, select the needle position with Manual Color-changing ( or the color-changing key) and press start key for embroidery.</p> <p>When encountering the color-changing code, the machine will stop automatically. The figure  appears, and the system awaits the manual color-changing order. At this moment, user needs to perform the manual color-changing</p>	Chapter 2.5



No.	Display	Name	Description	Reference Page
			(Press  or Color-changing Key on panel). After the machine turn to the needed needle position, user can press the start key for the embroidery (Manual Start).	
		Auto Color-changing Manual Start 	If the machine is set at Auto Color-changing, user should set the color-changing order in advance	Chapter 2.5
		Auto color-changing Auto Start 	(Click  and then  for setting). When user presses the start key for embroidery, no matter where the current needle rod locates, the machine will change the needle according to the set color-changing order and perform the embroidery. When encountering the color-changing code, the machine will stop automatically and shift to the pointed needle position according to the auto color-changing order. If the machine is set at auto start, the machine will begin the embroidery automatically; if it is set at the manual start, the user needs to press the start key for embroidery.	Chapter 2.5
4		Design Management 	Click it to enter the memory design management interface, which includes “select design”, “disk input”, displaying designs, creating new designs and monogram operation.	Chapter 6
5		Parameter Setting 	Click it to enter the parameter setup interface which includes color-changing order and the normal parameters like scaling down/up and repetition, as well as the general	Chapter 4











No.	Display	Name	Description	Reference Page
			parameters like, sewing parameters, machine application parameters and machine parameters.	
6		 Previous Page 	When the file inventory is more than one page, press this key is turn to the previous page. If it is at the top page, the system will keep still.	
		 Next Page 	When the file Inventory is more than one page, press this key is turn to the next page. If it is at the last page, the system will keep still.	
7		Coordinate information 	Display the information of current X/Y displacement. If user wants to clear that X/Y value, please click this button and press confirmation.	
8		Main Shaft Deceleration 	For setting the main shaft deceleration. When the main shaft reaches the lowest speed, this key will be unavailable.	
		Main Shaft Acceleration 	For setting the main shaft acceleration. When the main shaft reaches the top speed, this key will be unavailable.	
9		Current Needle Position	This figure is for the actual needle position at present. 0 is for the invalid needle position.	
		Current Color-changing Times	The initial value of it is 1. After the embroidery starts, this value will add 1 at each finish of successful color-changing.	
		Color-changing Order	This order is the sequence of the needle rods for changing color. The 3D figure is for the current needle position.	
10		Design Display Area	The design for embroidery will be displayed at this area.	



No.	Display	Name	Description	Reference Page
11		Network Connection Failure Status	Network Status (Disconnected , Connected , Successful Log-in)	
12		High-speed Manual Frame-moving Status	When the machine stops, press the manual frame-moving keys to move the frame, and the frame will move in the high speed. Switch between and can be activated by the switching key on the panel.	
		Low-speed Manual Frame-moving Status	Different from the High-speed Manual Frame-moving Status, it is used for manual adjustment of the frame position.	
		The main shaft stops at the right position (100°).	When the machine stops, the main shaft stops at the right position. At this moment, user can perform operations like color-changing and frame-moving.	
		The main shaft doesn't stop at the right position (100°).	When the machine stops and the main shaft doesn't reach the right position, user will need to turn the shaft to the 100° position manually by clicking	
		The main shaft runs well.	The main shaft runs normally at embroidery.	
		Assistant Operation Status	Click to have access to Assistant Operation Management interface and select any one of the embroideries, such as design border, line, cross and design outline. No matter which is selected, the	





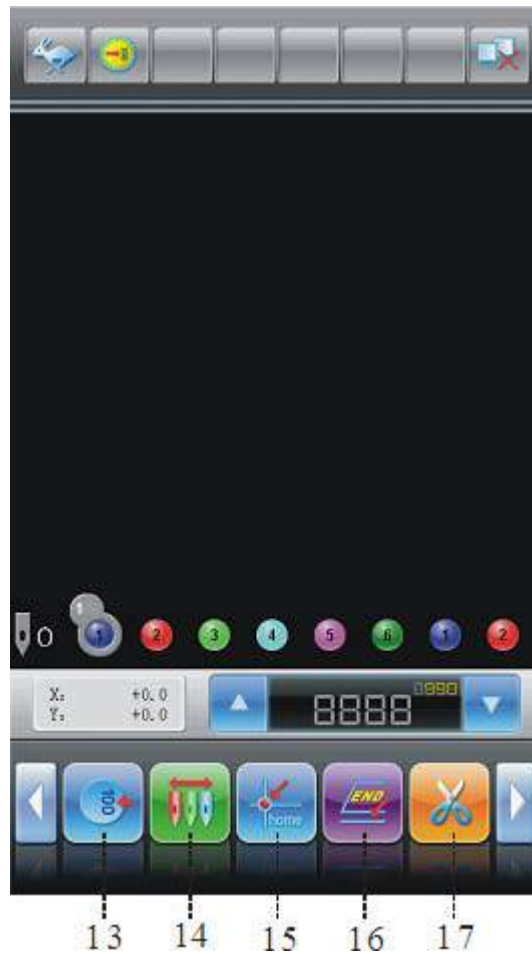



No.	Display	Name	Description	Reference Page
			mark  will be displayed at the main interface.	
		Thread Breakage	This figure will appear when the machine stops due to the thread-breakage	
		Color-changing	The status of color-changing at stop.	
		Cyclic Embroidery	The cyclic embroidery is available for this machine. Click  to have access to the Parameter Management interface where user can change the setting of the cyclic embroidery.	
		Offset Point	User can set offset point at this machine. When having access to the embroidery confirmation status  (before starting embroidery), user can click  to enter the Assistant Operation Management interface, where user can set the offset point.	





No.	Display	Name	Description	Reference Page
13		Main Shaft Manual Adjustment 	After stop, if the main shaft is not at the proper position , user can press this key to adjust the main shaft to the right position .	Chapter 2.5
14		Manual Color-changing 	When the machine stops and the main shaft is at the proper position , this operation is effective. After this operation, please have access to the manual color-changing interface, where user can click the corresponding needle position number to change the color.	Chapter 2.5



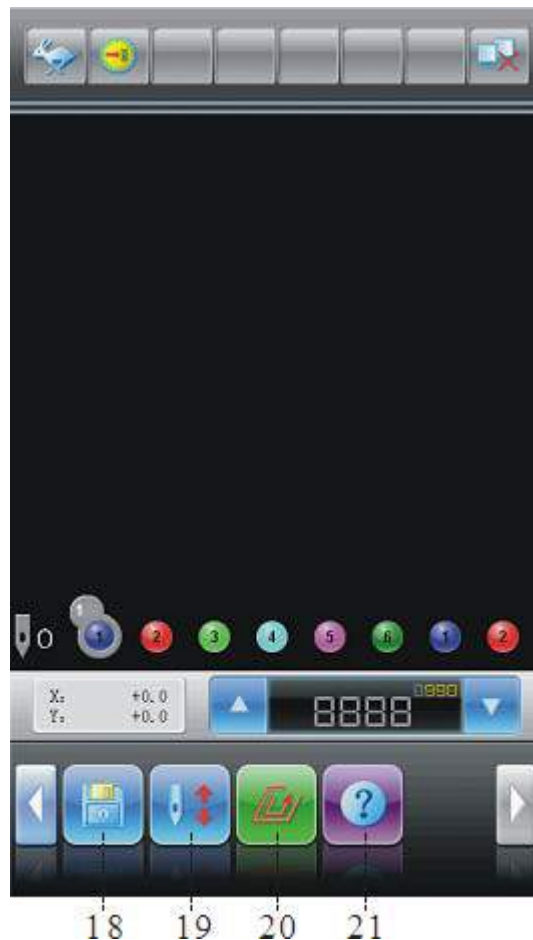





No.	Display	Name	Description	Reference Page
15		Back to Origin 	After the machine stops, user can click this key to have the frame automatically return to the origin of the current design.	Chapter 2.5
16		Back to Stop Point 	After the machine stops, user can click Manual Frame-moving key to move the frame (like appliqué). Then user can click this key to have the frame return to the stop point of current design.	Chapter 2.5
17		Manual Thread-trimming 	After the machine stops, user can click this key for the operation of manual thread-trimming (Including the operation for trimming bottom thread)	Chapter 2.5





No.	Display	Name	Description	Reference Page
18		Disk Management 	Click it to have access to the Disk Management interface, where includes the operations of floppy disk and USB disk.	Chapter 3



No.	Display	Name	Description	Reference Page
19		Assistant Operation 	Click it to have access to Assistant Operation Management interface, where includes the assistant operations during or before the embroidery, such as save/restore origin, set offset point, border operation, located idling, clearance of accumulated stitch number, clearance of X/Y travel amount.	Chapter 9
20		Other Functions 	After click it, the system will have access to the Other Function interface, where user can perform the operations, such as statistic inquiry, frame origin setting, power-off recovery, soft limit setting, machine authorization management, touching panel correction, time management and so on.	Chapter 10
21		Help 	It contains General Information and Instruction of Function Keys.	

2.4 Notes on Menu Status



If one menu is labeled with “”, it indicates that this menu is inaccessible and unchangeable. While if one menu is labeled with “”, then the menu is accessible and changeable.

2.5 Basic Procedure of Embroidery

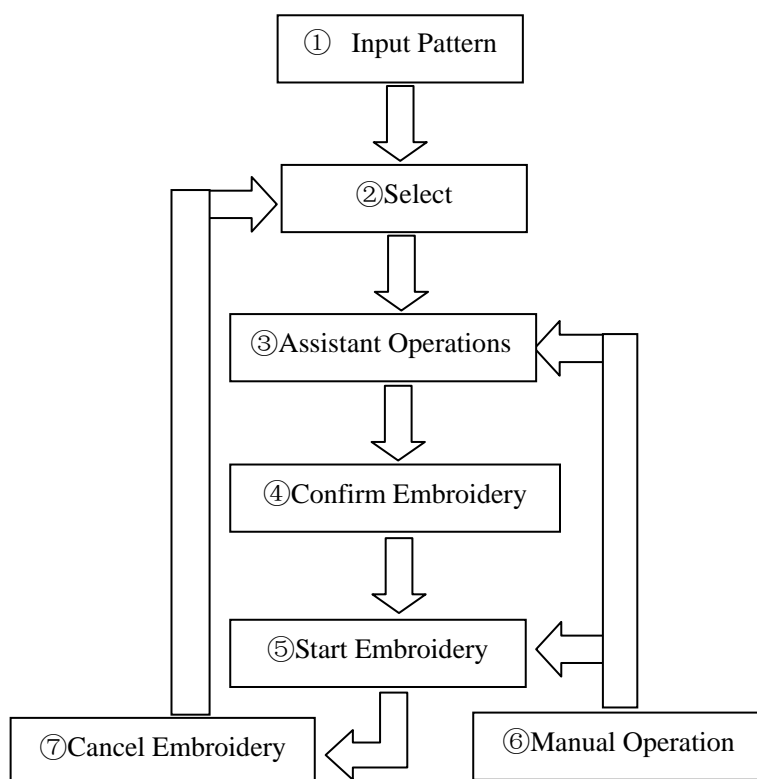

The machine carries out the embroidery basing on the designs saved in its memory. The following figure is the basic procedure of the embroidery:



I、 Input Design

The user can input designs through network, floppy disk or USB disk. Only with  displayed (successful registration), can it be possible to transmit designs by network. For disk operation, (USB disk included), click  in the main interface to enter into the “disk management” interface. You can also input designs by choosing , in the design management interface.

II、 Select Design

If the design management interface is not opened, click  in the main interface to enter it. If the screen is opened but the current window stays at another function interface, press the blue task switch key on the panel to enter the design management interface. Only in the status , can user be allowed to choose design for embroidery.

- 1、 In the Design Management interface, click “” to set the design for embroidery.

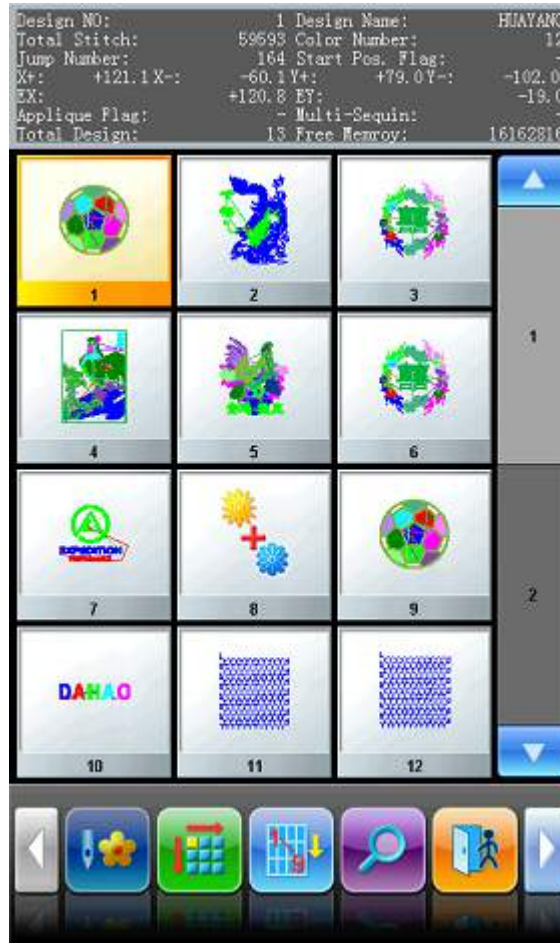

- 2、 If the design’s start point has been saved, the prompt “The start point of pattern is saved. Move frame to start point right now?” will appear when entering the main interface. Click  and the frame will automatically return to the start point.

III、 Assistant Operation

After choosing the design, the user will enter the main interface, and he can do the needed assistant operations before embroidery.

- 1、 Set repetition, rotation and scaling — click  to enter the parameters management interface.







2、 Set the color-changing order——click  and then needle to change color, after that the system will have access to the color-changing interface.

3、 Set appliqué ——click  to have access to the Design Management interface.

Click Other Operation to set the appliqué of design.

4、 For border inquiry, brooder idling. embroider standard line, embroider cross, embroider line, embroider outline of design, user can click  to have access to Assistant Operation interface





5、 Locate the design for embroidery at the center of frame.—— Click  to have access to the Assistant Operation interface. Attention: This function is to locate the soft limit to the center of the frame. For setting soft limit, please click  to have access to Other Functions.

6、 Save Start Point of Design —— Click  to have access to the Assistant Operation interface. Attention: user should set the frame origin before using the function for saving and restoring the start point of design. For setting the frame origin, please click  to have access to Other Function for the further operations.

7、 Setting Cyclic Embroidery —— Click  to have access to the Parameter Management Interface, where user should click “Embroidery Assistant Parameters” and set the cyclic embroidery according to the hints.

IV、 Confirm Embroidery



1、 After the assistant operations, user can click  to activate the window. After user selects , the figure  (Cancel Embroidery) turns to  (Confirm Embroidery), which means the machine has entered the Embroidery Ready Status.

If  is chosen, the embroidery machine will still be in the status of “Cancel Embroidery”. At this moment, the machine will keep still even user presses the start key. But the hint window will be displayed on the screen to ask user to confirm the embroidery

2、 Set Offset Point

After user confirms the embroidery, he can click  to set the offset point according to the hints if needed (Note: When the embroidery begins, the setting for the offset point will become unavailable).

3、 Set the Methods for Color-changing and Start

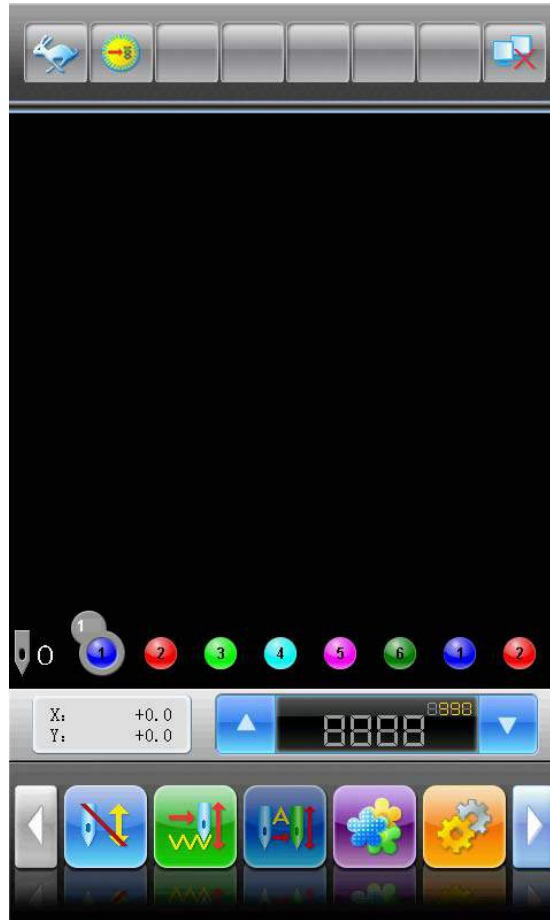

Click the position pointed in the above picture and the status will switch among



(Auto Color-changing, Auto Start),







(Auto Color-changing, Manual Start) and

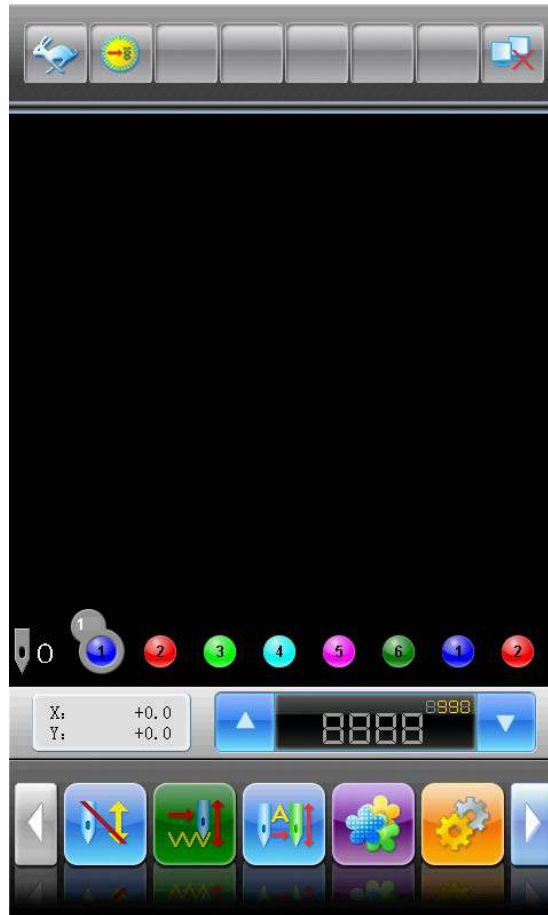

(Manual Color-changing, Manual Start)

4、 Set Status between Normal Embroidery and Idling



Click the position pointed in the above picture and the status will switch among  (Normal Embroidery),  (Low Speed Idling) and  (High Speed Idling).

V、 Embroidery Status

- 1、 Stop: Press the Start key to begin the embroidery (Including the low speed idling and the high speed idling).

Press the Stop key to retreat (Including the low speed idling and the high speed idling).

- 2、 Running: At normal embroidery, hold Start key to lower the speed of embroidery, release the Start Key to recover the speed.

Press Stop key to stop the embroidery (Including the low speed idling and the high speed idling).

VI、 Manual Operation

- 1、 Manual Thread-trimming:

When the machine stops, click  in the main interface to activate the

prompt window, where user needs to click “Trim Upper&Bottom Thread” to trim threads, or click “Trim Bottom Thread” to trim the bottom thread only. Clicking



is to quit the thread-trimming operation.



2、 Manual Frame-Moving:

When the machine stops, press the keys (“←”, “→”, “↑”, “↓”) to move the frame in the corresponding direction. Press the two neighboring keys at the same time to move the frame in the direction of the angle bisector. “↻” is the speed key for manual frame-moving. Press “↻” to switch between (High Speed) and (Low Speed).

3、 Clear the Frame Coordinates

When the machine stops, click and then click “Clear X/Y Displacement”

or click

X:	+0.0
Y:	+0.0

 on main interface directly to clear the XY displacements displayed in the main interface. The function can be used with manual frame-moving.

4、 Manual Color-Changing:

When the machine stops, click in the main interface to enter the manual color-changing interface. Then click the needle number for color-changing, and the



machine head will automatically move to the corresponding needle position. User can also change the color by pressing the color-changing shortcut keys marked with “+,-”. Please pay attention: if the user wants to automatically save the order of the manual color-changing (when the “Store Manual Color” in embroidery parameters is set as yes), user should operate it in the manual color-changing interface

5、 Adjust Main Shaft Manually:



Usually, the main shaft needs to stop at 100° at needle/color-changing, frame-moving and beginning embroidery. The user can manually turn the main shaft to

100° when it hasn't reached there. Click  in the main interface and then choose



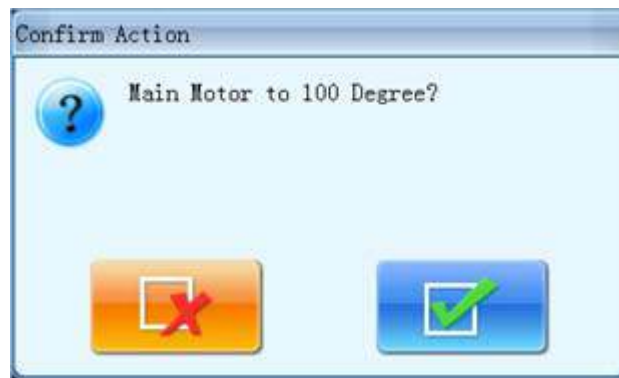

in the followed prompt to carry out the function.



After the operation, the icon  (main shaft not in the right position) will be replaced by  (main shaft in the right position).



6、 Back to Origin

In the main interface click  and choose  in the followed prompt. Then

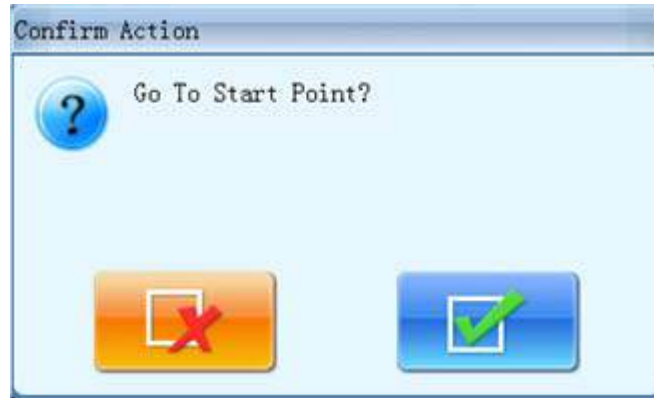
the frame will return to the start point.



7、 Back to Stop Point

Click  in the main interface and choose  in the followed prompt.

Then the frame will return to the stop point.

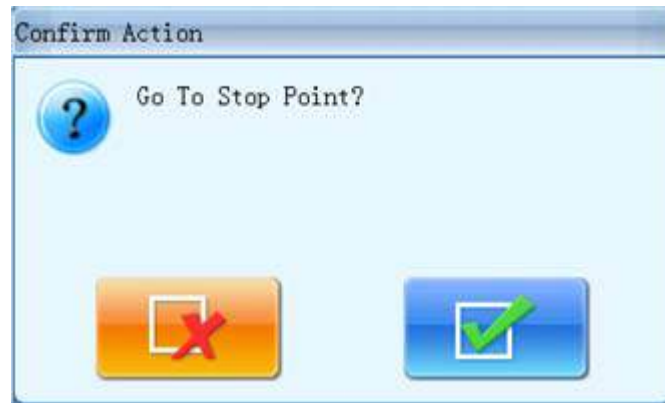



8、 Positioned Idling

Use this function after embroidery confirmation. Positioned idling enables the machine to move to the designated position without embroidering according to the user's requests. Click



in the main interface and turn to next page. Then the user can set the needle number, color-changing code and stop code for performing the positioned idling forward or backward.

9、 Needle Stop at Down Position

This function is designed for quilt embroidery. Click  in the main interface, press the "Needles Stop at Down Position", and select . The needle will prick into the cloth and a prompt will appear. After releasing the cloth (please make sure that the cloth is



separated from the frame), user should move the frame to the designated position and click . After this operation, the needle is still at down position. When the cloth is



placed on the frame again, click  to turn the main shaft to 100° manually.

10、 Manual Operations of AFC, Sequin and Cording Embroidery

Some machines are equipped with devices for AFC, sequin and cording embroidery. For such machines, click  and find the very parameter to have access to the operation menu of AFC, sequin and cording. Press the corresponding function keys according to the hints.

VII、 Cancel Embroidery

When the machine stops, click . Choose  in the followed prompt and

 (Embroidery Confirm) will turn to  (Confirm Emb Release).



2.6 Normal Embroidery, Returning and Patching

In embroidery confirmation status (in that moment, the “” is displayed), pressing start key is to order machine to perform the normal embroidery (holding the start key is to perform the slow embroidery). Press Stop during the embroidery to stop the embroidery.

When the machine stops, user can press the stop key again to order the frame to retreat along the original embroidery path. User can order the frame to go back for one stitch at each pressing. Holding the stop key at this moment is to have the frame to retreat continuously. After retreating for 10 stitches continuously (For different models, this stitch number might be different.), the frame can keep retreating even user doesn't press the stop key any more. At the continuous retreating, user can press the Stop key again to stop.



Generally, the retreating is for the mending operation. When the frame stops retreating, the user can press the Start key to perform the normal embroidery.





2.7 Relations among Normal Embroidery, Idling and Positioned Idling

Functions as idling, returning, etc. are intended for the convenience of patching. Low-speed idling, high-speed idling or positioning idling can be used according to the needs in embroidery. In the status of idling, the returning contains low-speed idling returning, high-speed idling returning or positioning idling returning.

In the main interface, you may press  /  /  to switch among

 (normal embroidery),  (low speed idling) and  (high speed idling).

After the setting at low-speed idling , the main shaft remains inactive when user presses the start key for normal embroidery, but the frame runs forward along the stitch trace. When user presses the stop key for returning, the main shaft keeps inactive, but the frame returns along the stitch trace.

After the setting at high-speed idling , the main shaft and frame remain inactive, the count increases. After user presses the stop key for halting, the frame moves directly to the actual position of the current count. When user presses the stop key for returning, the main shaft and frame keep inactive, but the count decreases. After user presses the stop key for halting, the frame returns directly to the actual position of the current count.

The positioning idling can move the frame directly forwards (or backwards) to a designated position, or to a latest color-change position, or even to a latest stop-code position.

In the main interface press  and the user can select forward/backward positioning idling by stitches, color change code or stop code. When the system returns to the main interface: Pressing Start key is to perform the forwards idling, while pressing Stop key is to perform the backwards idling.

2.8 Embroidery Operation

Stop: Press the Start key to begin the embroidery (Including the low speed idling and the high speed idling).



Press the Stop key to retreat (Including the low speed idling and the high speed idling).
Running: At normal embroidery, hold Start key to lower the speed of embroidery, release the Start Key to recover the speed.
Press Stop key to stop the embroidery.

2.9 Thread-Breakage Detection

Based on different working principles, thread-breakage detection devices have three types: thread take-up spring type, thread winding wheel (chopper wheel) type and mixed type.

For thread take-up spring type, it detects the thread-breakage by searching connection of take-up spring and contact point. When thread breaks, the spring will close to the contact point. In normal condition, this detecting type is sensitive to the face thread breakage, but can hardly detect bobbin thread run-out. In case you change the embroidery thread, or thread tension changes, you need to adjust spring pressure between the take-up spring and contact point. When the spring pressure is too large, there will be False Alarm; when the spring pressure is too small, there will be Missing Alarm.

For thread winding wheel type, it judges thread-breakage by detecting the winding wheel angle. It is very sensitive in case of face thread breakage; in most cases of bobbin thread run-out, the consumption of face thread will reduce, as a result, system will judge by statistic method and send out warning. Though it can almost avoid False Positive, it is not as sensitive as the spring-type.

For the mixed type method, the two can complement each other with their advantages, which results in sensitive and stabilized detecting effect.

2.10 Working Status of Embroidery Machine

The machine has three working statuses::





I、 Embroidery Ready  —— preset parameters; choose embroidery designs and other preparation work.

II、 Embroidery Confirmation  —— confirm the parameter settings to enter the quasi-running status.







III、 Embroidery Running Status  — embroidery.

Shift among these three working statuses:

In preparation status ( is displayed), after you select design for embroidery and set the parameters, please firstly press , then press . Now the machine is in embroidery confirmation status ( is displayed at main interface). Finally, presses the start key to embroider, which means the machine is in embroidery running status ( is displayed at main interface).

In embroidery running status ( is displayed at main interface). Presses the stop key to stop machine, now the machine is in embroidery confirmation status (Again, presses the start key to start the machine, the machine goes into embroidery running status).

In embroidery confirmation status () is displayed at main interface), firstly press , and then press  to release embroidery confirmation status. Now the machine enters preparation status ( is displayed at main interface).



Chapter 3 Disk Management

In disk management, users can input the designs in the disk to machine, and vice versa; meanwhile, users can enjoy some common disk managing actions, like erasing file or Inventory, initializing the disk, etc. Floppy disk and USB disk are both supported by this system. Users can save design data based on different types. The system recognizes formats like DOS, FDR and ZSK. However, FDR and ZSK files are read only (No deletion, initialization or output is available.). Design formats like DSB, DST and DSZ can be read by the system. For data output, design will be saved in the disk as DSB format.

3.1 Select Disk

Since the system supports several storage devices, user needs to select the objective disk for the operation.

- 1、 Click  in the main interface.
- 2、 “Disk Select” will appear. And then user needs to choose the disk for the next operation.







In this window all the storage devices will be displayed. Their information includes the icons, words and numbers. The icon is the device type. The  indicates the USB disk. The words are the file mark of the disk (if the disk has no file mark, the default letter will be used), and the number in the brackets is for the disk's digital symbol.

3、 Entry to Disk Management Interface



No.	Figure	Name	Description
1		File List	Display the design files and folders within the disk in icons. It's used to select files.
2		Previous Page	Turn to the previous page if the file list is more than one page. If it is at the first page, this key will be unavailable.
3		Refresh	Refresh the current folder.
4		Design Input	Upload the designs within the USB disk to the memory
5		Select All	Select all the items in the current folder (only in the multi-selection mode).





No.	Figure	Name	Description
6		Single-selection /Multi-selection	  Switch between single- selection and multi-selection
7		Exit	Exit from the disk management.
8		Next Page	Turn to the next page if the file list is more than one page. If it is at the last page, this key will be unavailable.





No.	Figure	Name	Description
9		Design Preview	Display the selected file and its information.





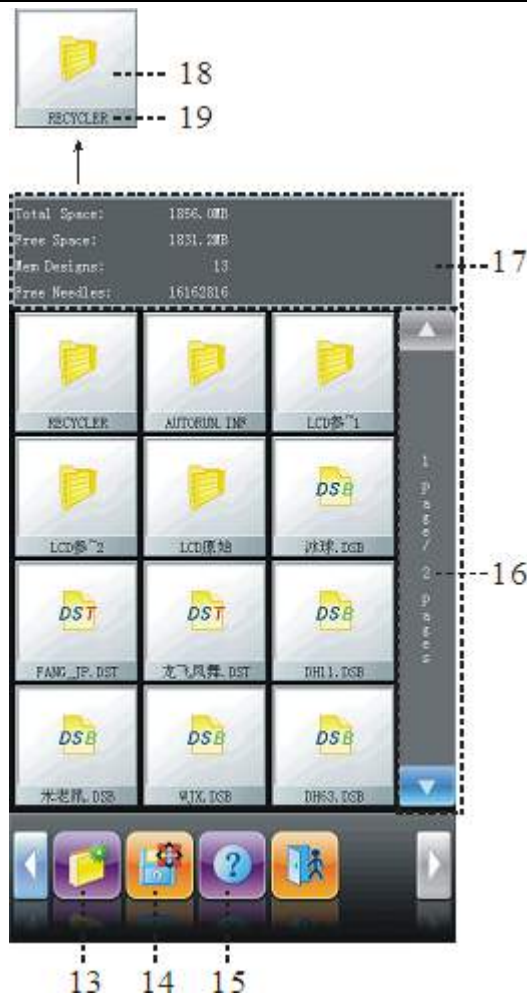

Chapter 3 Disk Management

No.	Figure	Name	Description
10		Back to Upper Level	Return to upper level
11		Deletion	Delete the file or file folder
12		Design Output	Save the design in the memory into the USB disk.



No.	Figure	Name	Description
13		Create Inventory	Create new file folder

No.	Figure	Name	Description
14		Disk Formation	Format the USB disk
15		Help	Display the help menu of the disk management interface.
16		Page Information	The current page number and total page number
17		Disk and Memory Information	Display the disk capacity, free space of disk, memory capacity and free space in memory
18		Figure of Object	Display objects in the figures:  : Inventory  : Design in DSB format  : Design in DST Format
19		Name of Object	File name or Inventory name of design

3.2 Select One or Several Designs

Before preview, input and deletion of designs, the objective design has to be selected first. The user can select one object at one time, or select several objects at one time to improve efficiency.

1、 Select One Object



The objects are in the unselected status as default. When one of them is selected, its icon and words will show a different color, and the information area will show its contents like stitch number and date.

2、 Click a Selected Object to Cancel the Selection



Click the selected object and it will become unselected again.

3、 Click the Switch Key of Single/Multi-Selection

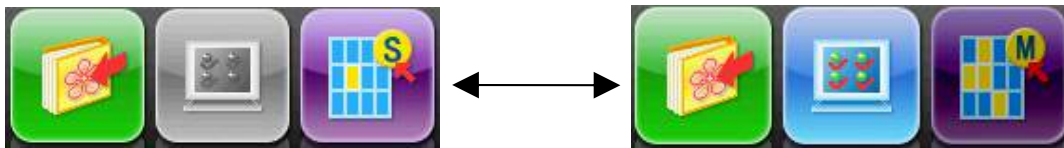

When user selects the objects, the system would be in single or multi-selection mode. In the single selection mode, one object is selected for one time and selecting another object will automatically cancel the last selection. Click the switch key to switch between the two modes. In the multi-selection mode the user can select several objects. In the single selection mode the switch key shows as when in the multi-selection mode it shows as .

4、 Select More Than One Object in Order

In the multi-selection mode click the several objects in order, so as to select them.



- 5、 Click  to select all objects in the current folder.

Only in the multi-selection mode can this key be effective. Click this key to select all objects in the current inventory.

3.3 Design Preview

- 1、 In the disk management interface, click the design for preview.



Design files and Inventories are shown in figure in the list. One page of the list contains 12 items. If the amount of the object within the current inventory is more than 12, the object list will be displayed in pages. Click the key to turn the pages and look for designs in another page. The selected object has a green frame and a different background color.

- 2、 Click 



The system loads the data from the disk and displays the design's image according to a certain ratio. At the same time the design's information and color-changing number will be shown in the information area.

Note: User can select more than one design for preview at a time. For the method, please refer to 3.2.

3.4 Design Input

To input the design within the disk to the machine's memory, the user has to select one or more files from disks at first, and then input the design number and name for the file to be saved.

- 1、 Select one or more file on the disk

- 2、 Click 



The system asks the customer to input the number and name of design saved in memory.

- 3、 The user inputs the number and name of design.



The system provides the minimum available design number as the default value. The customer can use the small panel to change the value. Refer to sequin operation for “Is multi-sequin Design?”. When several designs are input for one time, the user can only input the number for the first design.

To modify the design number and name, click the object item in the left window and modify it in the right window.

- 4、 Click



- 5、 The system will input the design data from the disk to the memory.

3.5 Design Output

The user can output the design from the memory to the current disk.

- 1、 Click



- 2、 Select the design for output

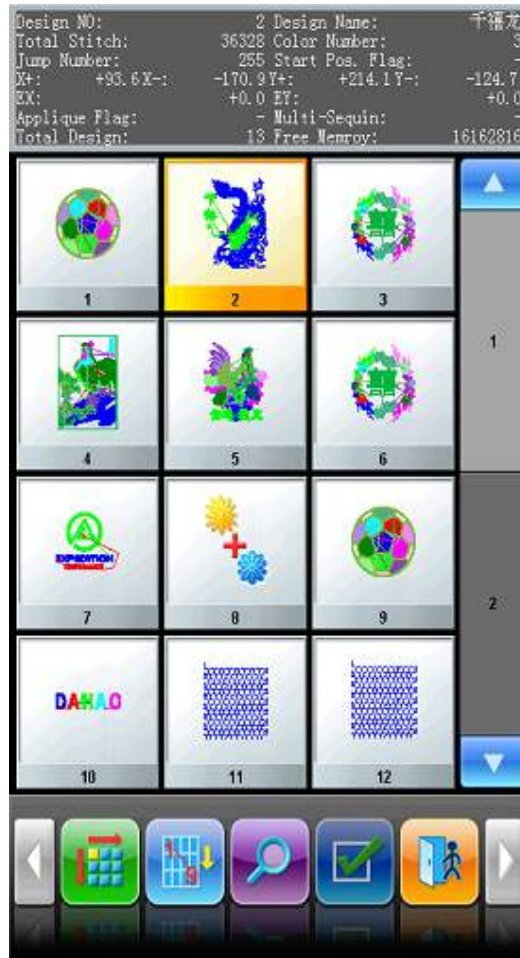

The system displays the list of memory design. The user needs select the design for output, and then click  .

3、 Input design name



The system uses the design name in memory as the default name for the design in disk. Use keyboard on the right to change the name.

At changing the design name in disk, user needs select the item in the left window at first, and then change it in the right window.

4、 The system returns to the disk management interface, at mean time, the list will be refreshed.

3.6 Inventory Operation

1、 Entry to Inventory:

Double click the icon of the object inventory to enter it. The system will load the item list of the inventory and refreshes the interface.

2、 Return to Upper Level of Inventory:



Click “” to let system return to the upper level of inventory and refresh the interface.

3.7 Format Disk

- 1、 Select the disk device for formatting (Refer to 3.1)



- 2、 Click “” to format the disk

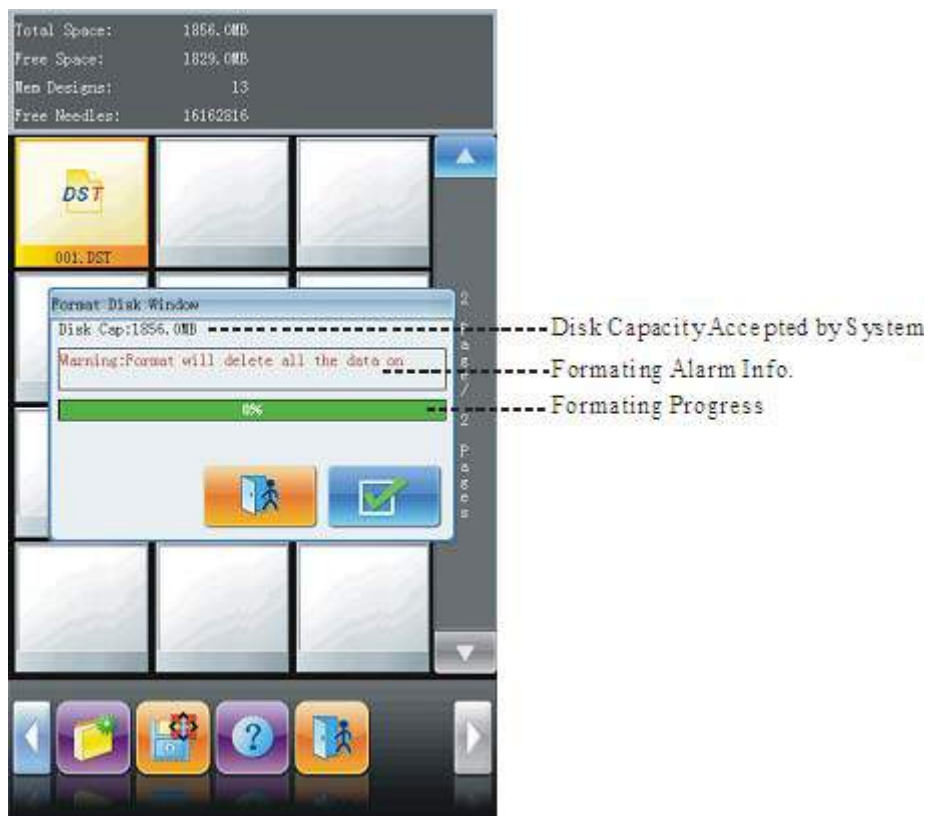

The system will display the Format Disk interface, where the storage information of the current disk, alert information for disk formatting and formatting process bar, as well as Start and back button, are displayed.

- 3、 Click 

System will begin to format the disk and show the speed with a process bar. After formatting, the system will display the prompt to show formatting success. Click the returning

key to return to the disk management interface.

Note: the system will format the disk in DOS format.

3.8 Deleting Objects in Disk (Including Designs and Inventories)

- 1、 Select one or more objects for deletion (Refer to 3.2)

- 2、 Click 



- 3、 System asks user to confirm the deletion.



Note:

If the user wants to delete an inventory, the system will delete all the files and sub-inventories within this inventory. If a file has the property of “Read Only” or “Disk Write Protection”, the file will be unable to delete.

3.9 Create a New Inventory in the Current Inventory

- 1、 Click 
- 2、 Input the new inventory name.



3、 Click



The system will create the corresponding folder in the disk and refresh the current list of objects.

Chapter 4 Common Parameters and Color-Changing Order

In this system each design has its own settings of the normal parameters (like scale and repetition) and color-changing order. When a new design is selected, the corresponding settings of normal parameters and color-changing order will become effective.

In this chapter, we will discuss the setting of the most frequently used parameters and color-changing orders. You can start the operations by touching  in the main interface.

Due to this system is able to perform the multi-missions at the same time, it's possible to set or change the normal parameters and color-changing order for the designs that are not embroidered at present. User can have access to these operations via the Other Operation interface in Design Management (please refer to Chapter Chapter 6).

4.1 Setting of Common Parameters

The common parameters include: “X-Y Scales”, “Rotate”, “Direction”, “Prior Mode”, “Rep. Mode”, “Rep. Prior”, “X-Y Repts” and “X-Y Interval”. Users can control the final embroidery results by adjusting these parameters.

Click  in main interface for entering the parameter setting interface:



The way for setting the parameter is similar to each other. This chapter will explain how to set the “X-Y Scales” as an example and give the definitions of other parameters (Refer to 4.1.1 as reference).

4.1.1. Setting X-Y Scales

This parameter controls the scaling percentages on X (horizontal) and Y (vertical) direction, so as to scale up/down the design.

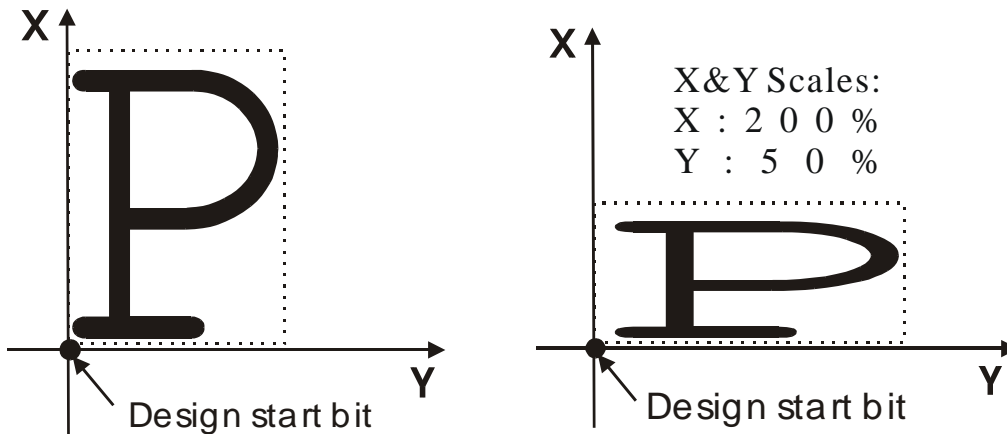

1、 Press the “X-Y Scales”





After users press the “X-Y Scales” in the parameter list interface, a parameter modifying window will appear in the right side of the screen.

2、 Adjusting X-Y Scales

Press the number panel in the parameter-setting window to change the scaling ratios on



X-Y direction. Press  to cancel the last input digit and press  to erase all entered digits. Pressing the “X Scale” and “Y Scale” can shift and mark the currently modified parameter.

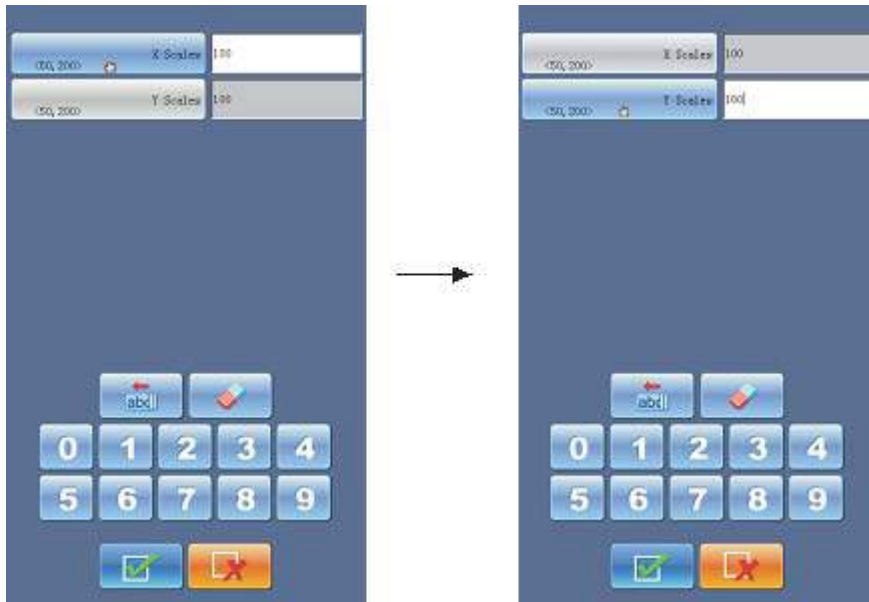

3、 Click  to save the parameters modified.

4.1.2. Rotate

Users can rotate the design to a certain angle by changing this parameter.

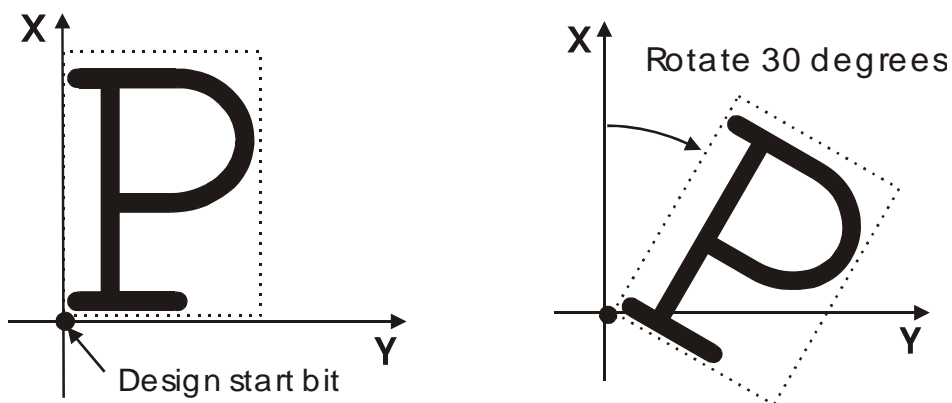

4.1.3. Direction

图案方向	p	q	d	o	q	o	b	o	p
刺绣结果	F	L	F	L	F	L	F	L	F

4.1.4. Prior Mode

There are two modes: “Rotation prior to scaling” and “Scaling prior to rotation”. When the user has set the parameters “X-Y Scales” and “Rotate”, the design will rotate first and then scale up/down. Otherwise it will scale up/down first and then rotate.

4.1.5. Rep. Mode

Currently, the Part Repetition is not available.

4.1.6. Rep. Prior

There are X prior and Y prior for users to choose.

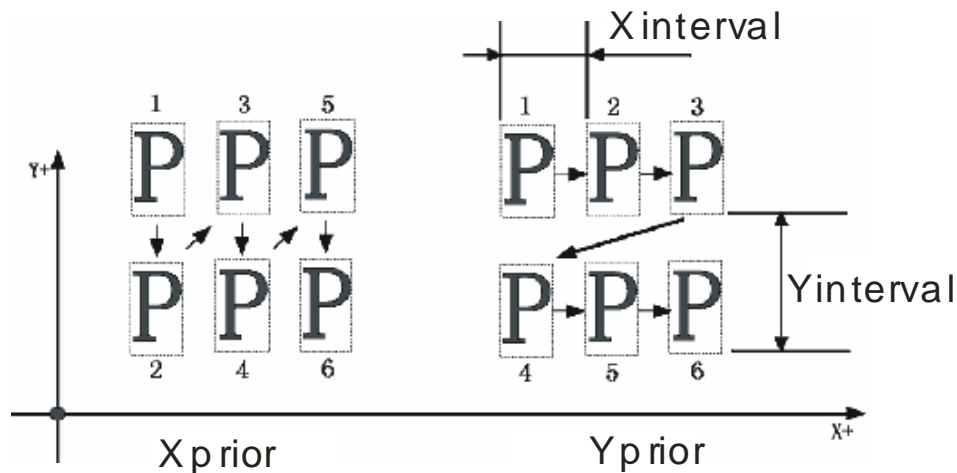

4.1.7. X-Y Reps

X Reps is the number of rows in repetition, and Y Reps is the number of columns in repetition. The above diagram shows that X Reps is 3 and Y Reps is 2. The largest set value is 99*99.

4.1.8. X-Y Interval







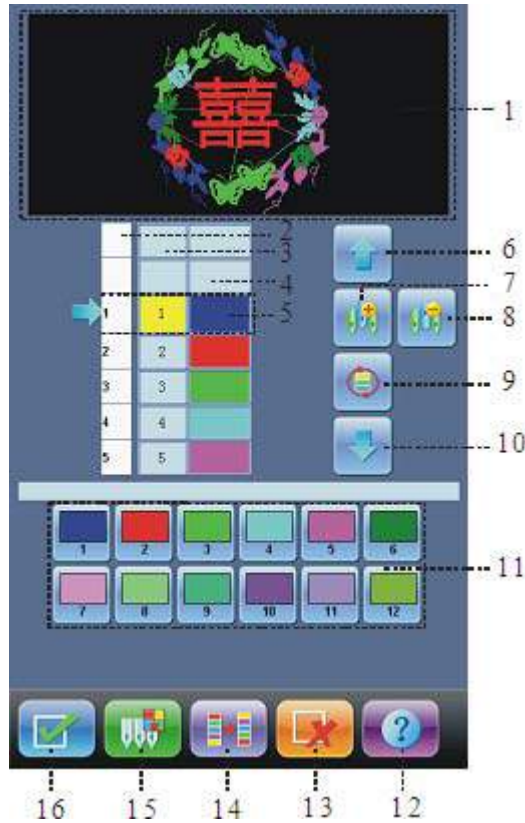

The above diagram also explains the meaning of this parameter.

4.2 Setting of Color-Changing Order

4.2.1. Color-Changing Interface



No	Figure	Name	Description
1		Design Display Area	Display the design according to real-time setting of color-changing order. Preview the result of color-changing.
2		List of Color Block Sequence Numbers	Display the sequence numbers of the color blocks in the design.
3		List of Needle Sequence Numbers	Display the needle sequence numbers corresponding to the color blocks.
4		List of Needle Colors	Display the thread colors for the color blocks in the design.
5		Current Position	Users can set, insert or delete needle bar number in current position.
6		Move Upward	Move upward the color-changing list to select the color block.















No	Figure	Name	Description
7		Insert a Needle Number	Click this key and a needle number to insert it in the current list of needle sequence.
8		Delete a Needle Number	Delete the needle number of the current operation position in the needle list.
9		Set Cyclic Needle Number	Cyclic setting according to the needle sequence number list before the current color block.
10		Move downward	Move downward the color-changing list to select the color block.
11		Needle Number Selection Area	Select needle number here.
12		Help	Display the help menu.
13		Cancel	Cancel the color-changing setting of this time and return.
14		Interchange Needles	Open the needle interchanging interface and set it.
15		Needle Color Setting	Select in the default color and set the color of each needle
16		Confirm	Confirm: Save the color-changing setting and return.

The design display area displays the designs which are under color-changing setting. After changing the color-changing order, the display of design will be renewed at same time which will have the effect after the change shown.

Color-changing order display area shows color block number, needle numbers and needle colors

Design display can be in parallel with the setting, insertion and deletion of needle number, which means users can set and change the color-changing order along with the display.



4.2.2. Setting of Color-Changing Order

- 1、 Click  in the main interface to enter the parameter setting interface.
- 2、 Click  in the parameter setting interface to enter the color-changing interface.
- 3、 Input the needle numbers in order in the needle number selection area. The design displayed in the design display area and the color list in the color-changing display area will be renewed along with the input of each needle number.
- 4、 Click   to check if the input color-changing order is correct.
- 5、 To change a needle number in the color-changing order, the user can click   to move the list, so as to put the target item to the current operation position. And then click the new needle number.
- 6、 In order to insert a needle number in the color-changing order, user needs click   to move the order list and to place the target item to the current operation position, and then click . Finally, he has to click the number of the needle to insert.
- 7、 To delete a needle number in the color-changing order, click .
- 8、 If the user has confirmed that the first N items are set correctly and hopes to repeat the settings of the first N items from the N+1 item, he can click   to move the order list and to place the item N+1 to the current operation position and then click .
- 9、 After confirming the input color-changing order, user can click  to save the color-changing order and return. Clicking  is to abandon the setting and return.

Note: For detailed color-changing operations in sequin or cording embroidery, refer to related chapters.

4.2.3. Set Needle Color

To make the color displayed in the screen get close to the color in real embroidery, this system can set all the needle colors used by the current design. This setting will be saved with color-changing order.

- 1、 Click  in the main interface to enter the parameter setting interface.
- 2、 Click  in the parameter setting interface to enter the color-changing setting interface.
- 3、 Click  to enter the needle color setting interface.

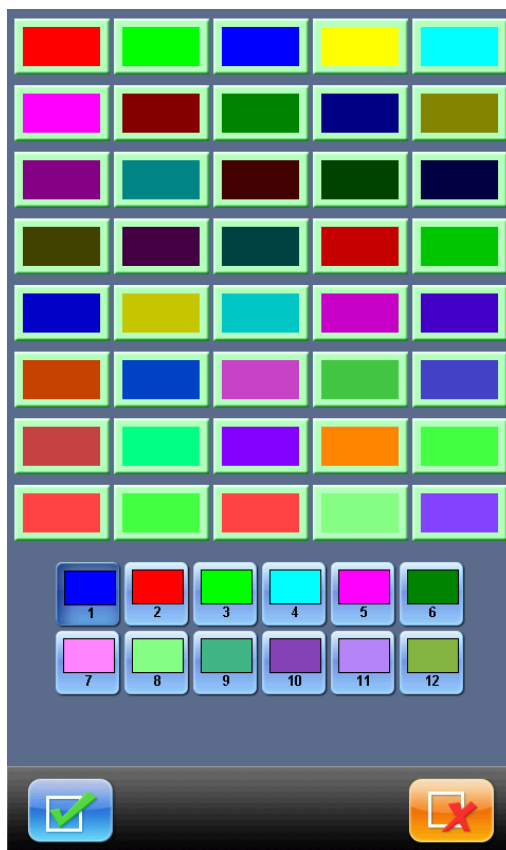



In the needle color setting interface, there are total 40 colors for selection.

- 4、 To set the needle color, select the needle first and then select the color from the 40 default color blocks. The corresponding color will be refreshed on the needle button.
- 5、 Click  to save the setting of the needle color and return to the

color-changing order setting interface; clicking  is to return to the color-changing order setting interface without saving.



4.2.4. Interchange of Needle Colors

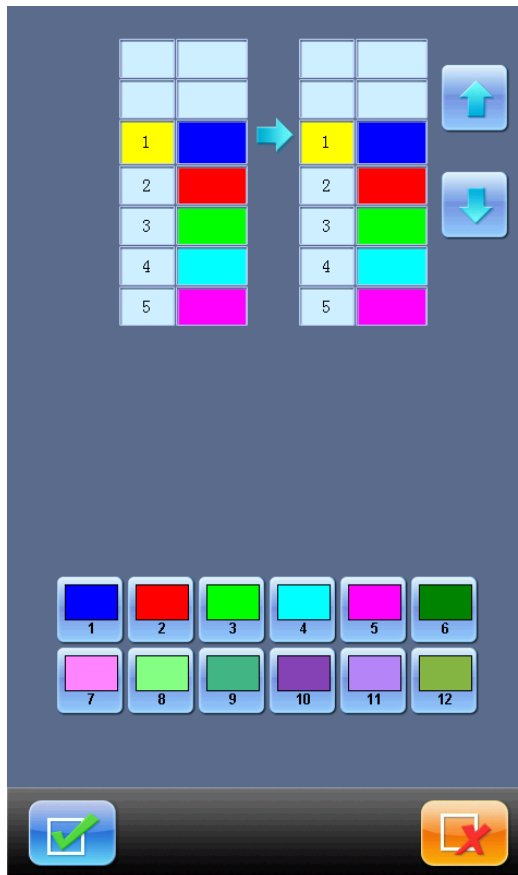

1、 Click  in the main interface to enter the parameter setting interface.

2、 Click  in the parameter setting interface to enter the color-changing interface.

3、 Click  to enter the needle color interchanging interface.



4、 To interchange the needle colors, click   to move the order list and select the needle and then another needle for interchange

5、 Click  to save the setting and return. Click  to cancel the setting and return.



Chapter 5 Setting of Embroidery Parameters

Based on function, embroidery parameters are divided into groups (please refer to Appendix 1 Parameter List).

Note: For the machine with encoding functions, the parameters are divided into three groups according to their authorizations: The parameters titled with “1” are the parameters without passwords, which can be different according to different designs or embroidery modes; the parameters titled with “2” are the admin parameters which admin password can be set; the parameters titled with “3” are the parameters specially designed on the basis of the machine character, which don't need changing at daily usage. The settings of the manufacturer password and the admin password, as well as the initialization of the parameters

should be performed at “Admin of Authorization” at Other Function interface  (Refer to Chapter 10).

- 1、 Click  in main interface.

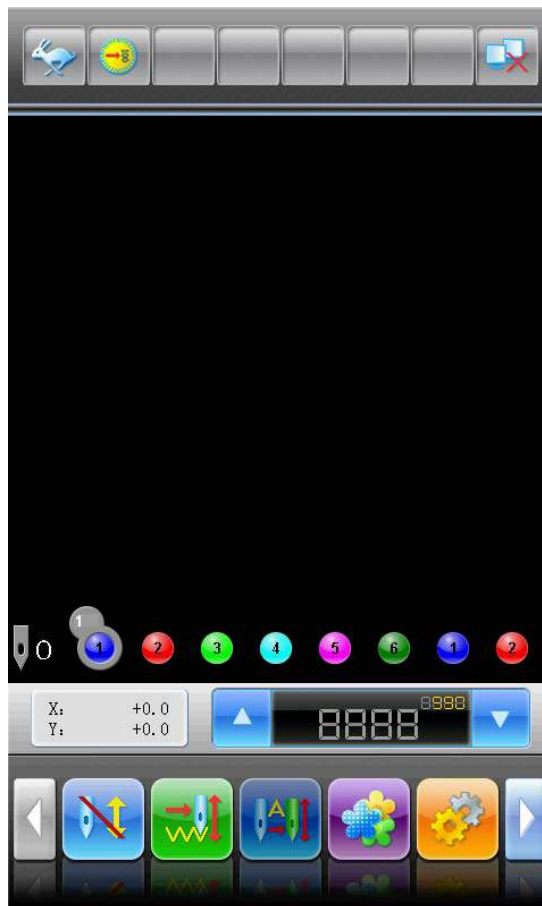

2、 Have access to the parameter setting interface, where user can select parameters for setting.



No.	Figure	Name	Description
1		Parameter List Window	Display the parameter list of the current group and their values.
2		Switch key	Switch among different parameter groups
3		Page Keys	
4		Color-changing	Set the color used by current design
5		Exit	Exit the interface.
6		Help	Display the help interface for parameter setting
7		Parameter Modification Window	When selecting the parameters in the list, user can change the selected parameters in this window.

Instruction:

- The number, name and value of each parameter are displayed in the parameter list window
- When a parameter group is set with a password, it can't be changed. There will be an icon in the parameter-changing window to show this situation. (Applicable for the machine with password-protection function)



5.1 Procedure for Setting General Parameters

The setting procedure is similar for each general parameter. You can follow the guide of this section to set parameters.

1、 Select Parameter Group

The user can use the keys on the bottom of the screen to look for the parameter. And ensure no password or the password has been input if the machine has set password. (refer to Chapter 10).

If you want to change the value of “Needles”, (which is D01 in machine parameters 1) click  to find machine parameters 1 and select it. Then all of its parameters will be shown in the parameter list window.



2、 Select Parameter



Select the parameter in the list. And in the right parameter-changing window there will appear keys to change the value. User can use these keys to change the current parameter.

- 3、 Change the current parameter in the parameter-changing window

Change the current parameter in the parameter-changing window.

- 4、 Click  to finish the setting of the parameter.

5.2 Instruction of Some Functions within General Parameters

There are brief introductions of the parameters in the appendix 1. At here, we will introduce some functions used in embroidery.

5.2.1. Cyclic Embroidery Function

This function is to increase the embroidery productivity.

When the parameter “To Do Cyclic Emb.” is set as “Yes”, the cyclic embroidery function is activated and the icon  will appear in the main interface. If this function is activated, the machine will automatically embroider the designated design again without any operation when completing it.

Usually, cyclic embroidery should accompany repetition embroidery and specially made design, and the parameter “Auto Origin” should be also set as “Yes”. Thus when the machine is embroidering the back fabric, the front one can be replaced. After embroidering the designated design, the frame will automatically return to the start point and the machine will automatically embroider the front fabric again and at this time it’s possible for user to replace the back one.



5.2.2. Memory of Manual Color-changing



In embroidery confirmation status, the user can choose whether to store the manual color-changing's needle position into the color-changing order unit. Its purposes are as follows: 1) if mistakes are found for the automatic color-changing order in embroidery, the color-changing order can be modified with manual color-changing operation. 2) When a new design is embroidered with manual color-changing once, the color-changing order will be set for the design.

To use this function, the user should set the parameter “Store Manual Color” as “Yes”. Note: the parameter value will automatically change into “No” at each end of embroidery.

5.2.3. Brake Adjustment (A Must for New Machine)

This function is to adjust the control parameters for braking, so as to fit machines with different mechanical characters, which is also able to change with the machine running. Thus this function can help the machinery parts to work better with the computer. The function depends on the parameters “Set Brake Para”.

“Set Brake Para” is to adjust the stop position of the main shaft. When the main shaft often stops at the position below 100 degree, the user can increase the parameter value. When the main shaft often stops at the position over 100 degree, the user can decrease the parameter value. Thus the user can adjust the value to let the main shaft stop close to 100 degree. The value can be set between 0 and 30.

After adjusting this parameter, the user can click the task swift key on the panel to return to the main interface. Click  and , to check the effects of the parameter adjustment. If the user is not satisfied with the effects, he can press the swift key on the panel to return to the parameter setting interface, where he can adjust the parameter setting again. Close the parameter setting interface in the end.

5.2.4. Forbid Design Output

The function is to forbid copying the designs in memory (into the disk). If the machine administrator set “No Output Design” as “Yes”, other persons are unable to output the designs to the disk. If the user needs to output, he has to cancel “No Output Design” first.

For using this function, user can set the administrator password in the system at first (Refer to 10.7). you can change this parameter after decoding the password of administrator.

Chapter 6 Memory Design Management

Memory design management includes selection of embroidery design, setting of designs, change of designs and operations for creating designs.

6.1 Memory Design Management Interface and Other Memory Design Operation Interfaces









In the main interface, click  to have access to the memory design management interface.

The memory design management interface contains: design image display area, navigation and pagination area, information area, menu area and management operation area. The design image display area can show 12 designs at most. If the total number of the design is beyond 12, the more pages will be needed. Navigation and pagination area can help switch to the designated page. The management operation area is to preview designs and set their order.



No.	Figure	Name	Description
1		Information Area	Display the detailed information of the selected design and the memory information.





No.	Figure	Name	Description
2		Design Display Area	Show the design files in memory by icons. It's mainly for selection
3		Set as Embroidery Design	In embroidery preparation status, the selected design will be embroidered.
4		Select Order Method	Click it to select the method for arrangement according to your needs.
5		Select Design Order	Choose the arrangement of designs displayed in normal order or reverse order.
6		Design Preview	Check the details of the design; scale up/down, move or simulate the design.
7		Quit	Quit the operation in memory design interface
8		Navigation & Pagation Area	It's used for quick switching to the designated page of memory design list.
9		Input Design to Memory	Open disk operation interface, and perform design input operation.
10		Other Operations	Click to open the other operation interface, where user can perform copy, deletion, combination, edition and other operations.
11		Help	Display the help menu of the memory design interface.



Click  to have access to the interface of Other Design Operations, where user can

perform other operations on design. (To operate a single design, user has to select the design for operation)



In this interface click the buttons to enter the corresponding operation interfaces. Please read the following paragraphs for detailed explanation. Click  or  to turn the page, and click  to return to the memory design management interface.

6.2 Select a Design to Embroider

- 1、 Select a new design (Make sure that the system is in preparation status .
- 2、 Click  in the main interface to enter the memory interface management interface.
- 3、 Select the design in the memory design area of the memory design management interface.
- 4、 Click  to set the selected design as the embroidery design. If the operation is completed, the system will close the memory design interface and return to the main interface.





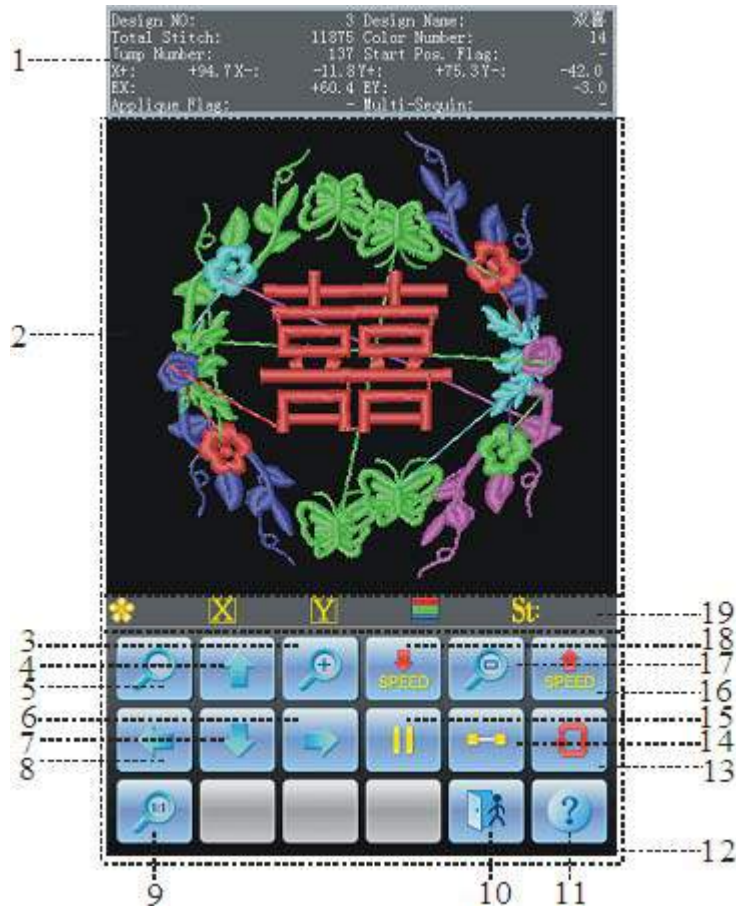





6.3 Memory Design Preview

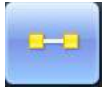

The selected design can be previewed in the memory design preview interface according to the designated way.

















No.	Display	Name	Description
1		Design Information	Display the information of the selected design
2		Design Preview Area	Display the design in the pointed method and speed
3		Scale up	Enlarge the design in the preview area
4		Move up	Move the design upwards
5		Scale down	Reduce the design in the preview area
6		Move right	Move the design rightward
7		Move down	Move the design downward



No.	Display	Name	Description
8		Move left	Move the design leftward
9		Actual Display	Display the design in the actual size. So the size of the design on the screen is the actual size of the design after embroidery.
10		Quit	Quit the operation in design preview interface
11		Help	Display the help menu of design preview interface
12		Patter Preview Operation Area	Control the method for design display
13		Redraw	Redisplay the selected design
14		Single Step Display	Draw the design according to the single step
15		Draw/Pause Switch	 Shift the statuses between drawing design and pausing display
16		Acceleration	Fasten the display of design
17		Full Size Display	Display the design full of the design preview area
18		Deceleration	Lower the speed for displaying the designs
19		Low Speed Information Display	Dynamically display the relating information at low-speed display

- 1、 Click  in the main interface to enter the memory design management interface.
- 2、 Select a design in the memory design area of the memory design management interface.
- 3、 Click  in the memory design interface to open the memory design preview interface.



4、 Click     to control the size of the displayed design; click     to control the position of the displayed design. Click   to control the speed of the display of designs. Click   to control the display and pause of design. Click  to turn to the pause status, where the single step of design can be displayed. For normal display, please press . Click  to redisplay the selected design.



6.4 Arrange the Memory Design

In order to find the interface quickly, the user can arrange the memory designs in the memory design management interface and the designs can be displayed in normal or reverse order. When the memory designs are more than one page, the current page will automatically switch to the first page after arrangement.

This system supports the following arrangement methods: by design stitch number, width, height, name, color and number.

The current arrangement way is by default shown on the design arrangement button. If the user wants to use another arrangement way, click the design arrangement button and select from the following menu and then the memory designs will be arranged in the set order.



- 1、 Click  in the main interface to enter the memory design management interface.
- 2、 Click  in the memory design management interface.
- 3、 Select the arrangement way from the pop-up menu, and the design image display area will refresh and arrange the items according to the selected order.
- 4、 Click  in the memory design management interface to select the normal or reverse order for displaying the items.

6.5 Copy the Memory Design

- 1、 Click  in the main menu to enter the memory design management interface.
- 2、 Select the design in the memory design image area of the memory design management interface.



3、 Click  in the memory design management interface to enter the memory design operation selection interface

4、 Click “Copy Design” to enter its operation interface. The system will automatically provide the smallest available design number and default design name. If

the user doesn't want to change them, please click .

5、 To input a new design number, click “New Design number” and input the new number in the pop-up window at right.



Copy Design	
Source Design number: <1, 400>	3
Source Design name:	双喜
New Design number: <1, 400>	14
New Design name:	双喜



abd | 

0 1 2 3 4
5 6 7 8 9



6、 To change the new design name, click “New Design name” and input the new name in the pop-up window at right.



- 7、 Click  to carry out the operation and return. Click  to cancel the copying operation and return.



6.6 Compile Parameter Design

This is to change the setting of color-changing order and normal parameters such as scaling up/down and repetition, which is attached to a specific design, so as to create a new design.

- 1、 Click  in the main menu to enter the memory design management interface.
- 2、 Select the design in the memory design image area of the memory design management interface.
- 3、 Click  to enter the design operation selection interface.
- 4、 Click “Compile Parameter Design” to enter its operation interface.





5、 If don't use the default values provided by the system, click “New Design number” or “New Design name” and input the new number and name.

6、 Click  to create a new design and return to the design operation selection interface. Click  to cancel the creating and return to the design operation selection interface.

6.7 Add Appliqué

The system has two ways for appliqué embroidery: manual frame out and automatic frame out.



Manual frame out: when meeting stop code at embroidery, the machine will stop automatically. User needs move the frame to the proper position for appliqué with the manual frame-moving button. Then click  and  to return to the stop point. At last, pull the bar for embroidery.

Automatic frame out has two ways: 1) moving frame to the offset point; and 2) setting the distance for frame-out. The operation is as follows: Firstly, set appliqué embroidery



function for the design. Secondly, when embroidering to the appliqué point, the machine moves to the offset point (which has to be set) or move the frame out according to the set distance. After patching, once user pulls the bar, the machine will automatically return to the stop point to continue embroidery.



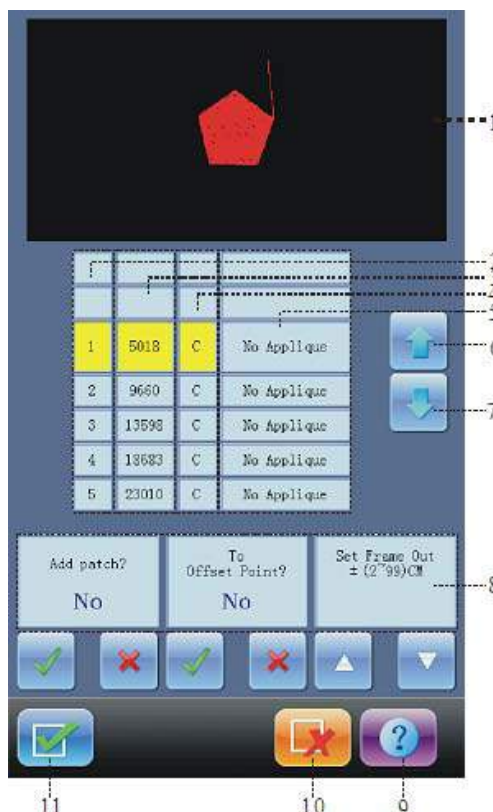

The following is how to add appliqué embroidery to the design:

- 1、 Click  in the main menu to enter the memory design management interface.
- 2、 Select the design in the memory design image area of the memory design management interface.
- 3、 Click  to enter the design operation selection interface.
- 4、 Click “Add Appliqué” to set appliqué embroidery. Following list will help you understand the interface:













No.	Display	Name	Description
1		Design Display Area	Real-time display of the design when embroidering to the appliqué point.



No.	Display	Name	Description
2		Number List	Show the sequence number of the position to set appliqué.
3		Stitch Number List	Shown the stitch number of the position
4		Type List	The stitch code type C: color-changing code S: stop code
5		Option list	Appliqué option of the position: 1. No Appliqué 2. Frame out to offset point 3. Frame out to a certain distance
6		Move upward	Move upward the appliqué list to select the position for appliqué.
7		Move downward	Move downward the appliqué list to select the position for appliqué.
8	From left to right	Appliqué embroidery choosing list	Choose whether to set appliqué embroidery.
		Whether to set the offset point	Choose whether to set the offset point
		The distance for frame to move out	Choose the distance for frame to move out: (2cm to 99cm) or (-2cm to -99cm)
9		Help	Help informations about appliqué embroidery
10		Yes	Save the appliqué setting and return.
11		No	Cancel the setting and return.

The interface display area shows the interface which is being set for appliqué. After user sets the appliqué point, the design will be refreshed and the result will be shown directly.

- 5、 Click   to move the list to the position for patching. Then click  after “Add patch?” to change it to .
- 6、 If user chooses to move the frame out to the offset point, please change .

(which is after “To Offset Point?”) to . If user chooses moving the frame to a certain distance, first change  (which is after “To Offset Point?”) to , and then click   to set the moving-out distance: (2cm to 99cm) or (-2cm to -99cm).

7、 Repeat step 5 and 6 to set all the patching positions of the interface.

8、 Click  to save the patching information and return to the operation

selection interface. Click  to cancel setting and return.

6.8 Make True Design Frame

This function is to create a new design according to the outline of the designated design.

1、 Click  in the main menu to enter the memory design management interface

2、 Select the design in the memory design image area of the memory design management interface.

3、 Click  to enter the design operation selection interface.

4、 Click “Make True Design Frame” to enter its operation interface

5、 If user doesn’t use the default values, please click the design number and design name to change them.



6、 Click  to create a design and return to the design operation selection

interface. Click  to cancel the setting and return.

6.9 Combine Design

This function is to combine two designs into a new one. The interval between the two designs is the distance from the end point of the first design to the start point of the second



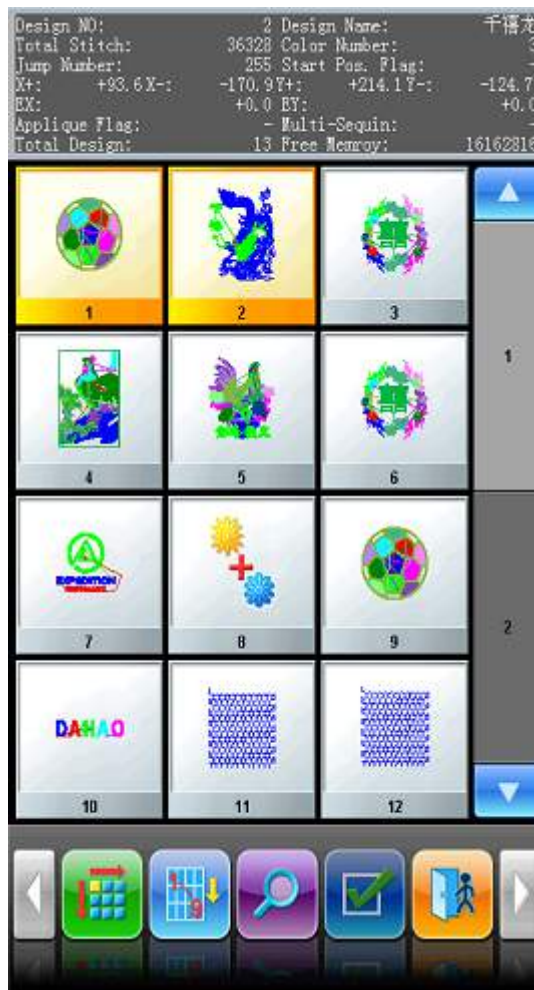

design.



- 1、 Click  in the main menu to enter the memory design management interface.
- 2、 Click  to enter the design operation selection interface.
- 3、 Click “Combine Design” to enter its operation interface.



- 4、 Choose two designs in design selection area, and click  to enter the interfaces for combining designs. If more than two designs are selected, there will be a prompt to tell you to reselect.
- 5、 If you don't use the default values, please click the design number and design name to change them.
- 6、 Click “X interval” and “Y interval” to input values.

Combine Design	
Source Design number1: <1, 400>	1
Source Design number2: <1, 400>	2
New Design number: <1, 400>	14
New Design name:	HUAYANG
X interval: <-1000, 0, 1000, 0>	0.0
Y interval: <-1000, 0, 1000, 0>	0.0

				
0	1	2	3	4
5	6	7	8	9
				



- 7、 Click  to combine the designs and return to the design operation selection interface. Click  to cancel the operation and return.

6.10 Edit Combined Design

The combined design (or Packed Design) means a design group combined from several certain (less than 99) memory designs after setting their parameters. The packed design is set as automatic continuous embroidery. In the memory design management interface the icon of the packed design is shown as . To embroider a combined design, user needs return to the memory design management interface after creating or editing the combined design. If it's already in the embroidery preparation status, click the design and “Set Emb Design”, and the system will automatically return to the main interface. Then after embroidery confirmation,



pull the bar for embroidery. The user can also edit the combined design into the common design by the editing function, so as to check and embroider the design.

- 1、 Click  in the main menu to enter the memory design management interface.
- 2、 To edit a saved combined design, user needs select the combined design first. To create a combined design, please carry out the following operations.
- 3、 Click  to enter the memory operation selection interface.
- 4、 Click “Edit Combined Design” to enter its operation interface.

The combined ID shows the current design number and how many designs the combined design is composed of. Display form is “design number (the total amount of designs)”.





Edit combined design	
(1/1)design number: <input type="text" value="2"/>	
<1, 400>	
X Scales	100
<50, 200>	
Y Scales	100
<50, 200>	
Rotate	0
<0, 89>	
Direction	P
Prior Mode	Rotate Prior

Navigation icons: left arrow, right arrow, numeric keypad (0-9), up arrow, down arrow, puzzle piece, checkmark, person icon, question mark.

- 5、 Set the parameters of the first design, including design number, scaling ratio, rotating angle, design direction and priority mode. Please read Setting of the Normal Parameters of Chapter 4 for reference.





Click  and then set the color-changing order of the current design in the combined design. The setting interface is in accordance with that in Chapter 4 .







- 6、 Click  to set several designs for packing. And click  to go back to change the parameters of combined designs.

If the current design is not the first of the packed design, user needs to set the interval between it and the first design. Please read input way in Chapter 4 for reference.

Edit combined design	
(2/2) design number: <1, 400>	0
X Scales <50, 200>	100
Y Scales <50, 200>	100
Rotate <0, 89>	0
Direction	P
Prior Mode	Rotate Prior
X space to 1st design: <-1000.0, 1000.0>	0.0
Y space to 1st design: <-1000.0, 1000.0>	0.0

0	1	2	3	4
5	6	7	8	9

- 7、 Click  to have access to the interface of editing the combined design.





The system will hint user to input the new design number and the new design name.

- 8、 Click  to save or click  to cancel the operation and return to the design operation selection interface.

6.11 Compile Combined Design

The action will help to turn the combined design to normal embroidery design.

- 1、 Click  in the main menu to enter the memory design management interface.
- 2、 Select the combined design that has been saved.
- 3、 Click  to enter the memory operation selection interface.
- 4、 Click “Compile Combine Design” to enter its operation interface.





System asks user to input new design number and new name.

- 5、 Click  to save or click  to cancel the operation and return to the design operation selection interface.

6.12 Satin Stitch Adjustment

This operation is to adjust the satin width in the design according to the need.

- 1、 Click  in the main interface to enter the memory design management interface.
- 2、 Select the design in the memory design image area of the memory design management interface.
- 3、 Click  to enter the design operation selection interface.



- Click “Satin Stitch Adjust” to enter its operation interface.

Label	Value
Source Design number: <1, 400>	1
Source Design name:	HUAYANG
New Design number: <1, 400>	14
New Design name:	HUAYANG
X Adjust: <-0.2, 0.3>	0.1
Y Adjust: <-0.2, 0.3>	0.1

Below the table, there is a numeric keypad with buttons for 0-9, a backspace button with a red arrow, and a confirmation button with a green checkmark. There is also a cancel button with a red 'X'.

- If don't use the default values, click the design number and design name to change them.





- Click “X Adjust” and “Y Adjust” to input the new value.

- Click  to adjust the satin width and save it as a new design to return to

the design operation selection interface. Click  to cancel the setting and return.



6.13 High-Speed Design

With this function, those long stitch forms can be cut to short ones, which will keep the embroidery speed at a high level.

- 1、 Click  in the main menu to enter the memory design management interface.
- 2、 Select the design in the memory design image area of the memory design management interface.
- 3、 Click  to enter the design operation selection interface.
- 4、 Click “Hi-Speed Design” to enter its operation interface.
- 5、 If user doesn’t use the default values, click the design number and design name and change them.
- 6、 Click  to create High-Speed Design and return to the design operation selection interface. Click  to cancel the setting and interface.

6.14 Set Common Parameters for Color-changing

Each design has its setting of color-changing order and normal parameters such as scaling up/down and repetition, which can be checked and set here.

- 1、 Click  in the main menu to enter the memory design management interface.
- 2、 Select the design in the memory design image area of the memory design management interface.
- 3、 Click  to enter the design operation selection interface.
- 4、 Click “Set design Params”, If the selected design is the current embroidering design, the embroidery parameter setting interface will pop up. Please read Chapter 5 for reference.



If the selected design is not the current embroidering design, the non-embroidery design parameter setting interface will appear.



For setting the color-changing and other parameters, please refer to Chapter 4 .

6.15 Delete Memory Design

This is to delete one or more designs in the machine memory.

- 1、 Click  in the main menu to enter the memory design management interface.
- 2、 Click  in the memory design management interface to enter the memory design operation selection interface.
- 3、 Click “Delete Design” to enter its operation interface.



4、 The interface is similar to the memory design management interface, in which the designs can also be sorted and previewed.

5、 Select the design for deletion, click  to activate the window, where

user can click  to delete the design and return to the Other Function interface



or can he click  to cancel the deletion and return to Other Function interface.

6.16 Move Frame to Make a New Design



The user often wants to embroider the boundary of a design before embroidering it, so as to help later patching. This function can create such a design, and you can select the new design to embroider the boundary.

1、 In embroidery preparation status, stop the frame to the point, where you want to create the design.

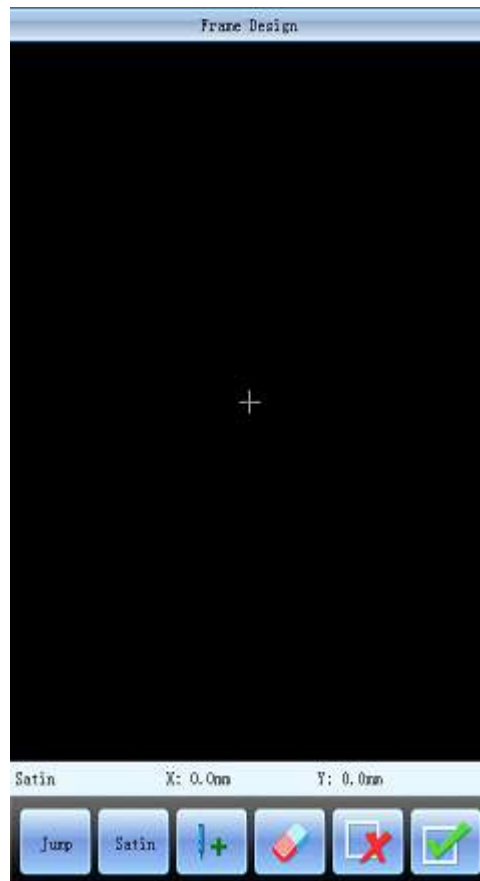

- 2、 Click  in the main menu to enter the memory design management interface.
- 3、 Click  to enter the design operation selection interface.
- 4、 Click “Frame to Make Design” to enter into its operation interface.





- 5、 Click the keys to shift between satin stitch and jump stitch. Click the manual frame-moving key to move the frame along the desired route. Click the confirm key at every turning point to confirm the trace.
- 6、 Click  when the editing completes. System will hint user to input the new design number.
- 7、 According to the hints, user needs input the number of the new design (The computer will provide a number for choice as well) and design name. Click  to create the new design.



- 8、 Click  to cancel the setting and return.

6.17 Divide Design

By operating this function, one design can be divided into two designs at a designated point.

- 1、 Click  in the main menu to enter the memory design management interface.
- 2、 Select the design in the memory design image area of the memory design management interface.
- 3、 Click  to enter the design operation selection interface.
- 4、 Click “Design Divide” to enter its operation interface.
- 5、 If user doesn't use the default values, click the design number and design name and change them.
- 6、 Click “Divide stitch number” to input stitch value.

Design Divide

Source Design number: <1,400>	1
Source Design name:	HUAYANG
New Design number1: <1,400>	14
New Design name1:	HUAYANG
New Design number2: <1,400>	15
New Design name2:	HUAYANG
Divide switch number: <1,59593>	29796

Navigation and Input Controls:



- Back arrow button
- Clear button (eraser icon)
- Number keypad (0-9)
- Confirm button (checkmark icon)
- Cancel button (red X icon)

7、 Click  to split a design into two and return to the design operation



selection interface. Click  to cancel the setting and return.

6.18 Clear all Memory Designs

This function is to clear all the designs in the memory. Be cautious.

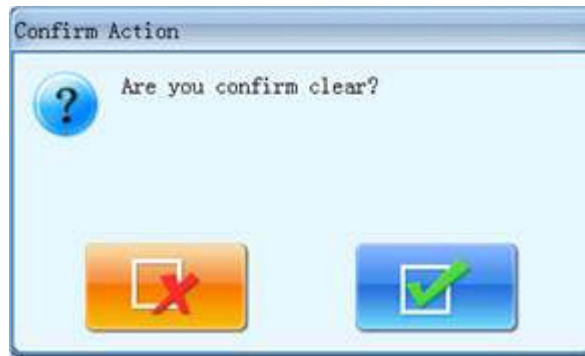
- 1、 Click  in the main menu to enter the memory design management interface.
- 2、 Click  to enter the design operation selection interface.
- 3、 Click “Clear All Designs”, and a confirmation window will appear.



- 4、 Click  to clear all the designs and return to the design operation selection interface. Click  to cancel clearing and return.



Chapter 7 Memory Design Edition

You can edit common designs smaller than 100000 stitches in the memory through this function, or establish a new design.

7.1 Start Design Edition

Choose the design for edition in the window of memory design management, and then

click .

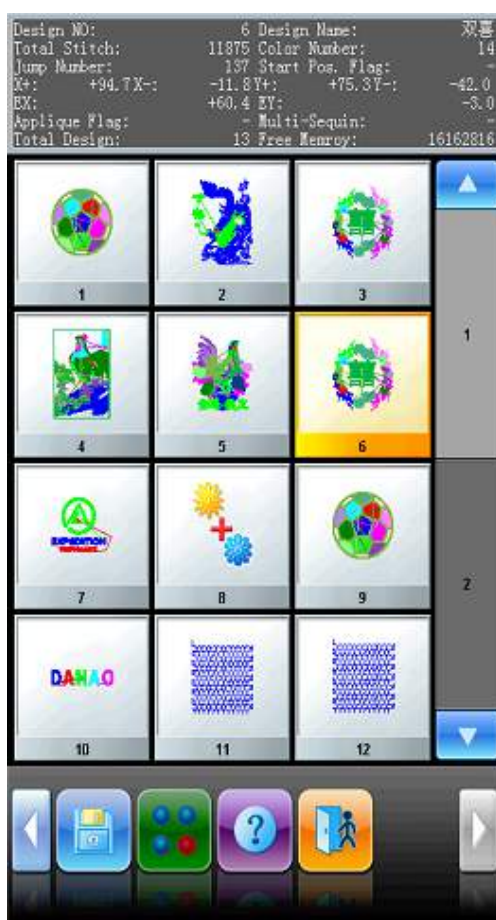

In “Other Design Management Functions”, click “Edit Design” key, after which, in the activated dialog window, click to start editing the current design; Click “Create New Design” to edits a new design; the detailed operations of “Edit Sequin of Current Design” will be explained in the chapter of JF Type sequin embroidery operations. (Note: the design selected can not be combined design, or system will give the warning of “not common design”)



7.2 Edit Design

7.2.1. General Information

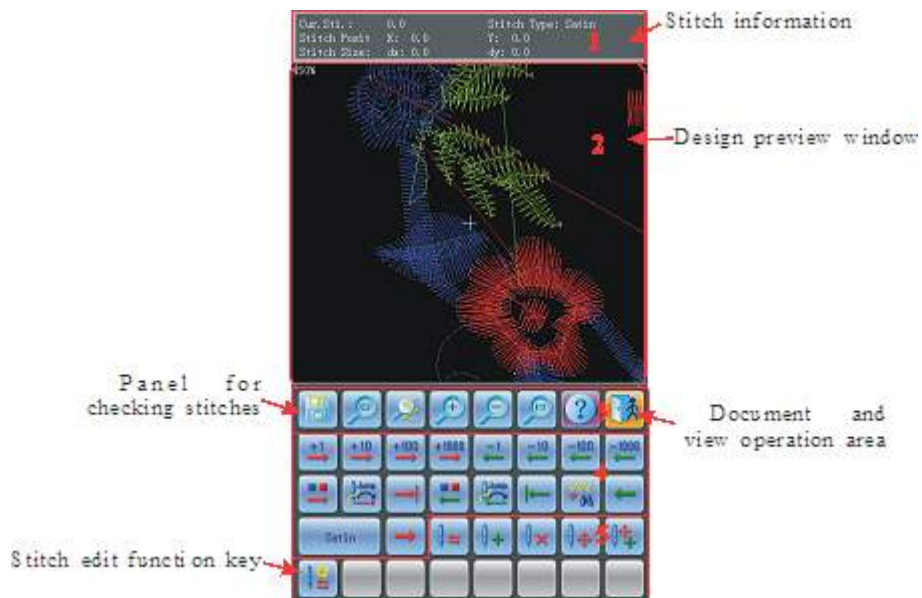

1、Stitch information: Information about total stitch amount, serial number, position and type of current stitch.



2、 Design preview window: preview design. In view, “+” is used to mark the position of current stitch. The stitch trace of current stitch is highlighted by white color.

3、 Document and view operation area: For the function of saving design, quitting current operation, looking up the help and zooming the view

4、 Panel for checking stitches: For locating the “current stitch” (stitch that need check and edit).

5、 Stitch edit function key: Use for switching stitch code, inserting stitch, deleting stitch and moving the stitch position.

7.2.2. Document and View Operation Area



Save the current design to a new document.



Reduce the design thus can see the all of the interface. If the design size is smaller than area of the screen, the system will show the interface at its actual size.



Enlarge the design to 450% to thus look into the detail of the stitch form." Current stitch" will move the middle position of the screen automatically.



Scale view. The scaling rate is 150% at every time



Actual view: the letter design is displayed in the actual size. At this moment, the size of the design on the screen is same to the actually embroidered one



Look up for the help menu of the design edition interface



Quit the design edition.

7.2.3. Locating Stitch

Set “current stitch” to some one stitch. At the same time, use “+” to mark the position of “current stitch” in the window of design preview. If there is no “current stitch” shown in the view, so the system will renew the view automatically, and show “current stitch” in the centre of view.



Move backwards 1/10/100/1000 stitches

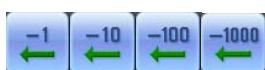

Move forwards 1/10/100/1000 stitches

 Move to next color-changing code.  Move to previous color-changing code.

 Move to next jump stitch.  Move to previous jump stitch.

 Move to last stitch.  Move to first stitch.

 Move to the previous or next appointed stitch code. Click the key in

centre, user can choose the type of stitch that needs checking.

7.2.4. Convert Stitch Code

After locating a certain stitch, click  key to convert the type of that stitch.

Stitches including X/Y position displacement, such as flat stitch, jump stitch, sequin-feeding and so on, whose stitch code type can be converted mutually.

Stitches excluding the X/Y position displacement, such as sequin-on/off, stop code, color-changing code and so on, whose stitch code type can be converted mutually.

7.2.5. Insert Stitch

Clicking  key can insert a new stitch code after current stitch.

If the current stitch is the last stitch of the design, so the insert position of new stitch is the displacement between the last stitch and previous stitch with same direction and same distance. If the last stitch inserts at the original point, then the newly inserted stitch position is: X/Y intervals are both 4.5mm.

If the current stitch in the middle of design, so the new stitch insert at the middle position between current stitch and next stitch.

7.2.6. Delete Stitch

Position the stitch, click  to delete that stitch.

7.2.7. Move Stitch

Position the stitch, click  to move that stitch.



When user presses “Only Moves Current Sti”down, the absolute position of all of the stitches behind current stitch will keep still. If that key flicks, the relating position of current stitch and all of the stitches behind it will keep still, which means that, at the same time of moving the current stitch, the absolute positions of stitches behind it are changed correspondingly.

Clicking can change the distance of moving at each time. Means to move 0.1mm at each time, means to move 1mm at each time, and means to move 5mm at each time.

While moving the stitch form, user can use “+” to mark new position of stitch form automatically in the window of design preview. After click “YES”, modification are submitted to the system.

7.2.8. Add Stitch Continuously

Press to activate continuous stitch adding function. “Current Stitch” will automatically relocate to the last stitch.



Users need to locate cursor to the right position by clicking direction keys. Press to insert a stitch to that point; then user can move the cursor add more stitch form.

By clicking , user can adjust the moving speed of cursor.

Chapter 8 Letter Design Operation

System can generate letter design based on the built-in letter database. .

8.1 Generate Letter Design

Click  to enter into design management interface.

Click “”.

Click “Generate Letter Design” to enter letter design parameter input interface.

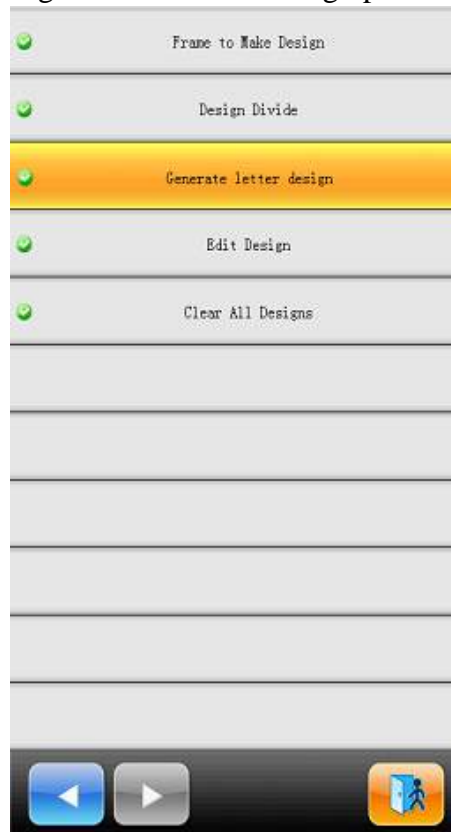

8.2 Input Embroidered Letter String and Basic Parameters

After opening the window of parameter input, user can enter letter input interface automatically.



Chapter 8 Letter Design Operation



Click certain parameter in the list, and then you can input parameter into the window in the right side of interface.

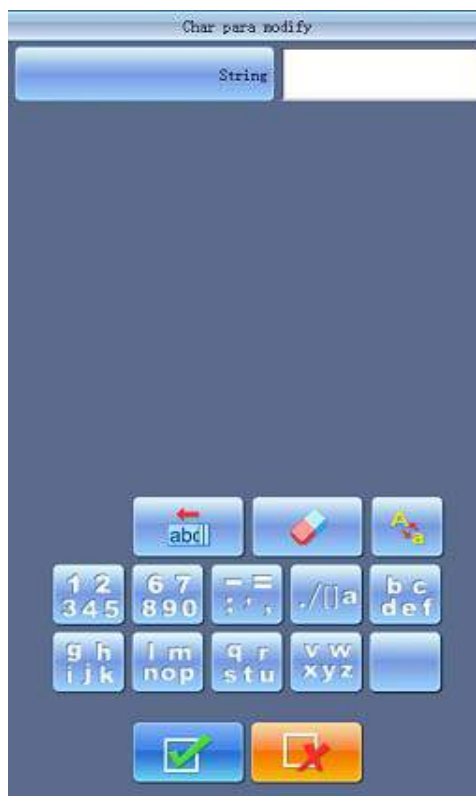



Parameters displays at left side of the screen, while the input window is at the right. After user adjusts the value, they also need to click  for saving.

“String”: the letter list that will be embroidered.

“Font”: means letter font for embroidery. The font selected here will be applied to all the letters. If you want to set font for an individual letter, please do operation in letter design adjustment interface.

“Arrange type”: the arrangement method of letter. It supports 4 types of arrangement, including “horizontal” “vertical” “up arc” and “down arc”.

“Char space”: means space between letters, the unit of which is 0.1mm.

“Char angle”: means when the arrangement method is arc, whether the angle of the each letter will change along with the position of arc.

“String rotate angle”: the rotating angle for whole letter string.



“Char height scale”: increase or reduce the height of letter.

“Char width scale”: increase or reduce the width of letter.

“Density”: means distance between each stitch within letter design. The value is smaller, the density is higher.

“Char rotate angle”: rotating angle of each letter to its centre.

“Change color between letters”: whether to add color-changing code before each letter.

After setting letter design parameter, use can click  to enter window of “letter design adjust”. Click  to quit the function of letter design.

8.3 Adjust Letter Design

1、 Letter Design Adjustment Interface

Letter design adjustment interface is shown as below:



The operation key is divided into 5 rows in the screen, the first two rows are the function keys for adjusting the arrangement of the letters(for whole rank), the second two rows are the keys for adjusting the selected letters, and the last row are the function keys for the function of view and files. The centre of screen is the area to show letter design.

Generally, user should set the parameters, such as whole arrangement method of letter string, rotate angle of letter string and interval of letter string (The keys of the first two rows at the bottom of the screen); select the very letter, and then adjust the arrangement parameter of that individual letter.

Letter design display window: the crosses at centre are the coordinate; intersection is origin (0,0). The letter rank surrounds the origin automatically.

2、 View and File Operation



“Stitch Form”: show/hide the stitch form. Hiding the stitch form can improve

operation speed.

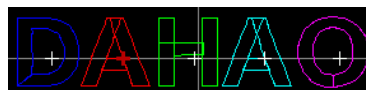



“Enlarge”: Enlarge to show the detailed part of the letter design.



“Reduce”: Reduce to show the window of letter design.



“Actual”: Show the letter design in the actual size. At this time, the size of design in interface is equal to actual size.



“Center”: Scale up/down the diagram, so as to show the whole design for checking.



“Move”: Move the letter design manifestation window, to check different part of the design. Clicking this key can show or hide the 5 direction keys that are used to move the diagram.



“Left”, “Right”, “Up” and “Down”: Move letter design toward each

direction. “Center”: Move the design to the original position.



“Save”: It is used for saving the edited letter design. After clicking that key, the system will show the window where user can input the design number design name. According to need, change the design name and design number (the serial number are not recommended for modification generally), then click confirmation to start saving.



“Exit”: Quit from “Create Letter Design”.



“Help”: Help for “Adjust Letter Design” interface.

3、 Keys for Adjusting the Parameter for Whole Arrangement

If you adjust the parameters for whole rank after the edition of the individual letter, the edition of the individual letter will be probably replaced. There are 4 arrangement modes.



“Horizontal”: Rank the letters horizontally





“Vertical”: Rank letters vertically



“Up Arc”: Rank letters in arc bending upwards



“Down Arc”: Rank letters in arc bending downwards



“Fix Letter Direction”: When user ranks the letters in arc, the letter angle will not

change along with the position of arc, but fix at a certain angle



“Angle follow”: When user ranks the letters in arc, the letter angle will change along

with the position of arc (letters will be vertical to the arc)



“Increase Radian”: When user ranks the letters in arc, this key can enlarge the

radian of reference arc

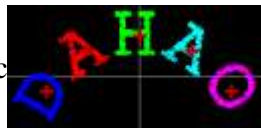

“Reduce Radian”: When user ranks the letters in arc, this key can reduce the radian

of reference arc



“Whole Anticlockwise Rotate”: Anticlockwise rotate the whole letter

bound

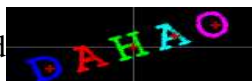



“Whole Clockwise Rotate”: Clockwise rotate the whole letter

bound







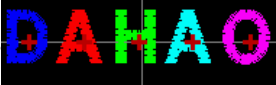



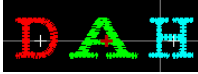

 "Extend Letter Interval": Increase the interval between the letters
 

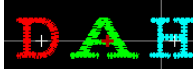

 "Reduce Letter Interval": Reduce the interval between the letters
 

4、 Keys for Selecting Letter at Adjustment

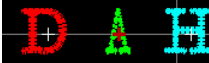

 "Selection Switch": switch the selected letters. User has to select a certain letter and then to carry out the edition for it. The red "+" in the center of letter means the letter has been selected . The system will pick out all letters as default. After user clicks the "select switch" key, the system will pick up the first letter, and then pick up the second, depending on this kind to push. After the system picks up the last letter, if user clicks "select switch", the system will pick up all the letters again.
 

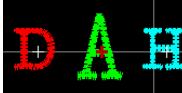

 "Increase Width": Increase width of selected letter.
 

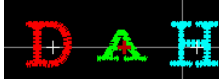

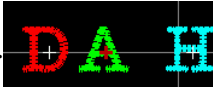
 "Reduce Width": Reduce width of selected letter.
 



 "Increase Height": Increase height of selected letter.
 



 "Reduce Height": Reduce height of selected letter.
 

 "Move Left": Move the selected letter to left.
 

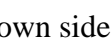
 "Move Right": Move the selected letter to right.
 

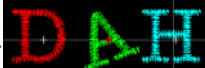

 "Move Up": Move the selected letter to upper side.
 

 "Move Down": Move the selected letter to down side
 



 "Anticlockwise Rotation": Use the letter as centre ("+" in the centre of letter), and rotate the selected letter anticlockwise.
 

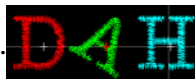

“Clockwise Rotation”: Use the letter as centre (“+” in the centre of letter), and rotate the selected letter clockwise.

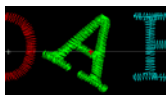

“Increase Density”: Increase the stain stitch density of the created letter design.



“Reduce Density”: Reduce stain stitch density of the created letter design.



“Horizontal Overturns”: Overturn the selected letter horizontally.



“Vertical Overturns”: Overturn the selected letter vertically.



“Color-changing switch”: Set or cancel the color-changing before the selected letter.





“Change Font”: Change font of selected letter. After user clicks this key, the system will give the dialog window for selecting font, choose one you wish, and confirm the change.



“Return” key is use for returning the window of letter design parameter input. If you need to change embroidery letter string, you can click this key to turn back to the previous interface to carry out the modification. All of adjustments for individual letter in this window will disappear.

8.4 Save Letter Design

After finishing the letter design edition, user can click  key. Appoint the new design number and new design name in the pop-up window, then click  key to save them.



After the confirmation of the saving, the system will return to the interface of “Adjust Letter Design”.

If you don't want to edit letter design, then press  to exit. System will show the following message.



Chapter 8 Letter Design Operation



Press  to save, or press  to return to “Other Design Management Functions”.



Chapter 9 Assistant Operation

The user can carry out these functions and perform some normal assistant operation by clicking the keys on the Assistant Operation interface.

Click  in the main interface to have access to the Assistant Operation interface.





Because there are too many assistant functions to list in one interface, you need press page key to turn the page.

The interfaces of the Assistant Operation share the same structure. User only needs to press the corresponding keys to perform the operations. Some functions may be unavailable in some statuses. In this case those keys will be attached with the icon .





9.1 Save Design Start Point

If the origin of the frame has been set (refer to “Set Frame Origin/ Power-off Protection”, Chapter Chapter 10), the machine will save the start position of the current design at the embroidery preparation status or before embroidery. The start position will be kept in machine memory.

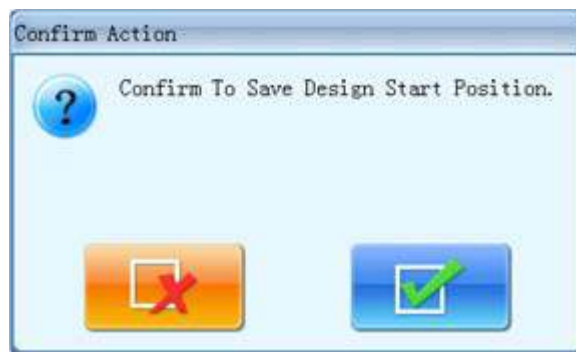

- 1、 Move the frame to start position.
- 2、 Click  in the main interface to enter the assistant operation interface.
- 3、 Click “Save Design Start Position”. System will ask user to confirm action.点
- 4、 Click 



Click  to save the current frame position as the design’s start point. Click  to cancel the above operation.

9.2 Restore Design Start Point

If you have saved the start position of current design, you can use this function to locate the frame to that saved start point.

- 1、 Click  in the main interface to enter the assistant operation interface.
- 2、 Click the “Restore Design Start Position”.
- 3、 Click  to restore start position
- 4、 Frame moves to the saved start position.

9.3 Locate Design to Center

This function is to move frame to position and locate the center of the design to the center of frame software protection that is set by the system, so as to embroider the design at the center of the frame when user presses the start key. (See “Set the Frame’s Software Protection”, Chapter Chapter 10).

- 1、 Click  in the main interface to enter the assistant operation interface.
- 2、 Click the key of “Locate Design to Center”.
- 3、 System asks users to confirm.

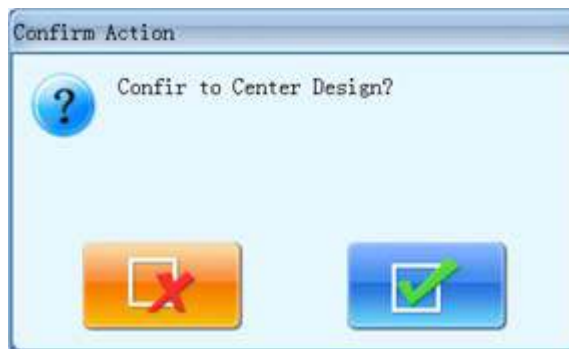

Click  to confirm and the system will calculate the center and move the frame to start position.

Click  to cancel the above operations.

- 4、 System returns to the main interface.

9.4 Check Border Information of Current Design

With this function, users can check the border information of currently embroidered design.

- 1、 Click  in the main interface to enter the assistant operation interface.
- 2、 Click the key of “Check Border Info of Current Design”.

System will show the border information of current design on the interface.

- 3、 System will display design border information.





Click  to turn off the window.

9.5 Move Frame along Design Border

This function is to move the frame along the design range to check if the design exceeds the limits. When the frame meets the limits during this process, system will make adjustment itself, so as to avoid the damage to the machine frame during the embroidery.

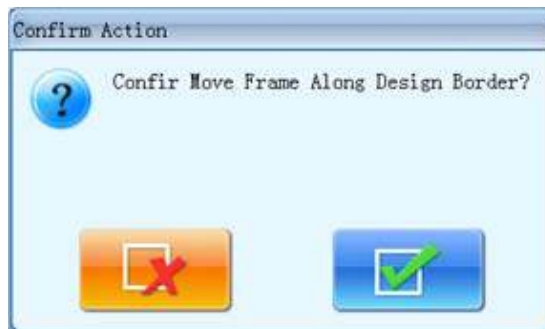
- 1、 Click  in the main interface to enter the assistant operation interface.
- 2、 Click the key of “Move Frame along Design Border”.
- 3、 System will ask users to confirm.



Click  to confirm and the system will move the frame along the design border.

Click  to cancel the operation.

9.6 Embroider along Design Border

The function enables system to calculate the design's peripheral data and generate the temporary data for embroidery. This function should be used at embroidery preparation status.

- 1、 Click  in the main interface to enter the assistant operation interface.
- 2、 Click “Emb along Design Border”.
- 3、 System will ask users to confirm operation.

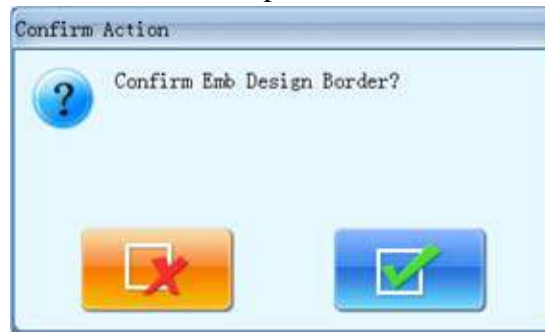

Click  to confirm or click  to cancel the operation.

- 4、 System will calculate the design’s temporary data, enter the embroidery confirmation status and return to the main interface.

System will show  on the interface. The user press Start to embroider the design range.

After finishing it, the system will automatically come back to embroidery preparation status.

9.7 Embroider Cross

System can embroider a cross at the current position. The size of the cross is adjustable.

- 1、 Click  in the main interface to enter the assistant operation interface.
- 2、 Click the key of “Emb Cross”
- 3、 System will enter into parameter setting interface for embroidering cross.



Users can set the X/Y length.

- 4、 Click 

System will generate the required data, have access to the embroidery confirmation status and return to main interface. Then the main interface will show . When user presses the start, the machine will embroider the cross. After finishing it, the machine will returns to preparation status.

9.8 Embroider Line

The system can embroider lines basing on the user's needs.

- 1、 Click  in the main interface to enter the assistant operation interface.
- 2、 Click “Emb Line”.



- 3、 Input the coordinates of the first point in the line.

The system will ask the user to input that coordinates in the window.

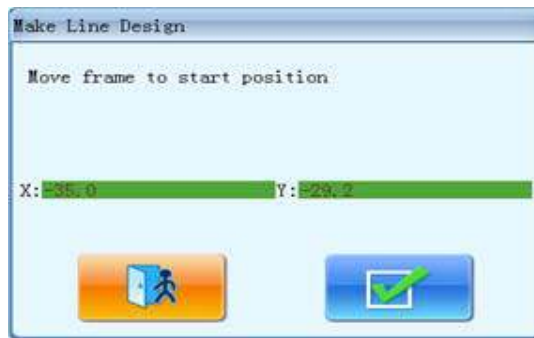

You can use the manual frame-moving key on the panel to move the frame to the start point of the line, and clicks  to input the coordinates of the first point.

- 4、 Input the coordinates of the second point in the line.

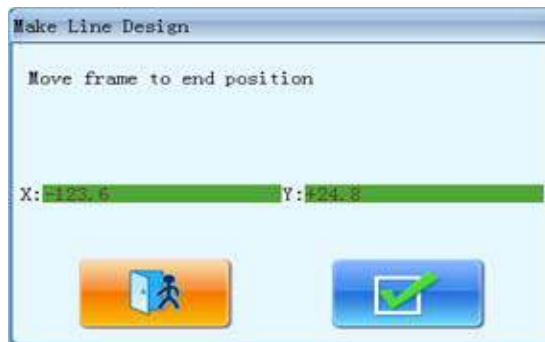

The user uses the manual frame-moving key on the panel to move the frame to the end point of the line, and clicks  to input the coordinates of the second point.

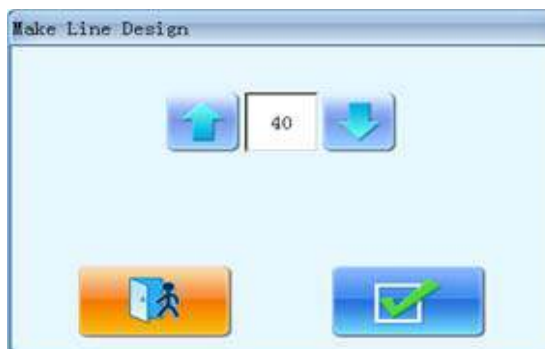

- 5、 The system will create the temporary data of the line, enter the embroidery confirmation status and return to the main interface.

The main interface will display the . And the user can press the Start to embroider the line. After finishing it, the machine will return to the preparation status.





9.9 Embroider Design Outline

System will generate temporary outline data according to the current design. Users can press the Start to embroider.

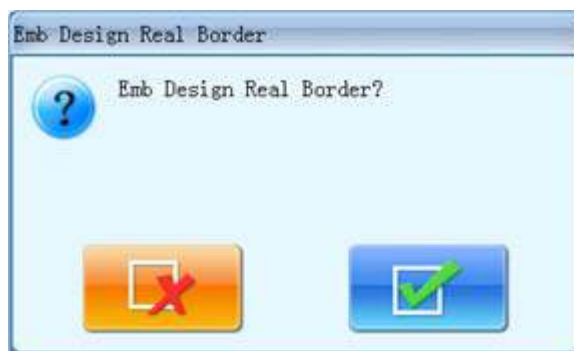
- 1、 Click  in the main interface to enter the assistant operation interface.
- 2、 Click the key of “Emb Design Outline”.
- 3、 System will calculate and wait for the confirmation from user.



The system will calculate the outline data, generate the temporary data and ask the user to confirm the above operations. Click  to confirm or click  to cancel the operation.

- 4、 The system will return to the main interface and have access to embroidery confirmation status.



The main interface will display . And the user can press the Start to embroider the outline. After finishing it, the machine will return to preparation status.

9.10 Set Offset Point

The offset point can be set at any point other than the start point. When the machine starts embroidering after the settings, the frame will firstly move from the offset point to the start point and start normal embroidery. After embroidery, the frame will move back to the offset point. Moreover, the offset point is also the standard for frame to move out at appliqué embroidery. The function can only be used under the embroidery confirmation status and before embroidery.

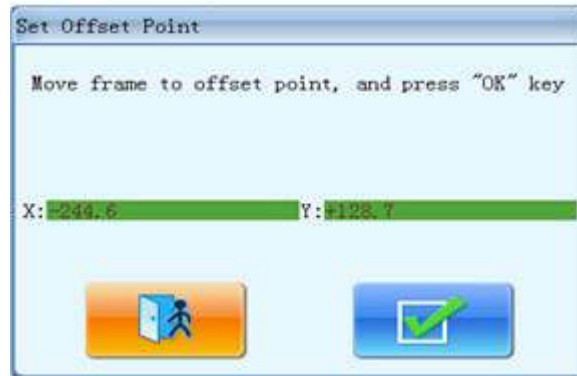
- 1、 In Embroidery Status, Click  in the main interface to enter the assistant operation interface.
- 2、 Click the key for setting the offset point.
- 3、 Move the frame to the offset point



The system will ask the user to move the frame to the offset point and then display the coordinates of X and Y. Press the frame-moving key to move the frame to the offset point, and then click  to confirm. Or click  to cancel the operation.

- 4、 System will save the position of the offset point and return to the main interface.

9.11 Needle Down

This function is designed for whole cloth embroidery (quilt embroidery). After part of the embroidery is finished, the needle will stop and prick into the embroidery cloth to fix it. After user releases the cloth, the machine will move the frame to the designated position. When the cloth is fixed on the frame again, next operation for the embroidery can be performed. This function can only be used under the embroidery confirmation status.

- 1、 Click  in the main interface to enter the assistant operation interface.
- 2、 Click the key of “Needle Down”.
- 3、 Confirm needle down action

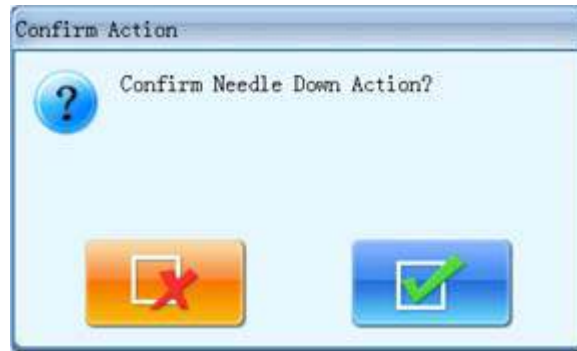

You can click  to confirm operation, and then the needle will prick into the cloth.

Click  to cancel.

- 4、 Release cloth, move frame, and then press Enter



Users need to release the cloth and move frame to designated point, then click  to confirm.

- 5、 After user confirms the frame-moving, system will returns to the main interface.
Customers need to fix the cloth, and then press the Start to continue embroidering.

9.12 Reset X/Y Displacement

This is to clear the X and Y displacements.

- 1、 Click  in the main interface to enter the assistant operation interface.
- 2、 Click Reset X/Y Displacement key.
- 3、 System will set current X/Y value to 0.

Customers can check the current X/Y value on the main interface.

9.13 Reset Total Stitch

Clear the total stitch number.

- 1、 Click  in the main interface to enter the assistant operation interface.
- 2、 Click reset total stitch key.
- 3、 System set the current embroidered stitch number to 0.

User can see total stitch number in the machine statistics.



9.14 Positioning Idling

Operations about positioning idling should be under the status of “”.

According to customers' requirements, the function can move the frame to certain position without embroidering. Customers can select stitch counts, color-changing stitch code or stop stitch code to idle forward (backward).

9.14.1. Forward Idling

- 1、 Click  in the main interface to enter the assistant operation interface.
- 2、 Click “Shift Frame Forward stitches”
- 3、 Input the stitch number

System will have access to the interface for inputting the forward stitch number. Customers need to click  to confirm the operation, or click  to cancel the operation.



4、 System returns to the main interface, press start key to have the frame float the pointed position.

9.14.2. Backward Idling

The operations are similar to “Forward Idling”. The only difference lies in is to “press Stop key”.

9.14.3. Go to Next Color

- 1、 Click  in the main interface to enter the assistant operation interface.
- 2、 Click “Go to Next Color Change”.
- 3、 Confirm operation.

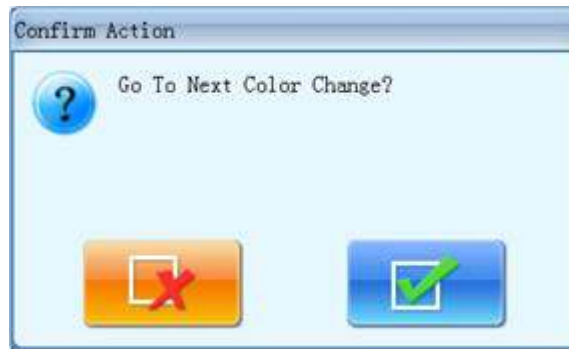

- 4、 System will return to the main menu. Pressing the Start will have frame to go to next color-changing code.

9.15 Cording Embroidery

Beneath the “Positioning Idling”, the operations are for the cording embroidery. For the machine equipping the cording devices, user can operate the relating devices.

- 1、 Click  in the main interface to enter the assistant operation interface.
- 2、 Click page keys to search the parameters so as to operate the cording embroidery.
- 3、 Select the wanted operation according to the hint.

Attention: The valves V1~V4 are for the operations of quilt embroidery; for the operations of sequin embroidery and cording embroidery, please refer to the corresponding chapters.



Chapter 10 Other Functions

These functions can be used during the usage, including machine maintenance, information inquiry and system settings.

Click  in the main interface to enter the “Other functions” interface, which is a list of function keys. Pressing these keys is to perform the corresponding functions.



The interface is similar to that for assistant embroidery. The words on the keys can help user to understand the functions.

10.1 Check Emb Related Parameters

The user can get information of the current design's parameters and some machine condition with this function.

- 1、 Click  in the main interface to enter the “Other functions” interface.
- 2、 Click “Check Emb Related Parameters”.
- 3、 System will show the current embroidery parameters.

They include: Design No, Total Emb Stitch, Free Memory, Cyclic Emb, Frame Origin, Software Frame Limit and Offset Point. Click  to return after viewing all the parameters.



10.2 View Statistics Info

- 1、 Click  in the main interface to enter the “Other functions” interface.
- 2、 Click “View Statistics Info”
- 3、 System will display statistics information interface

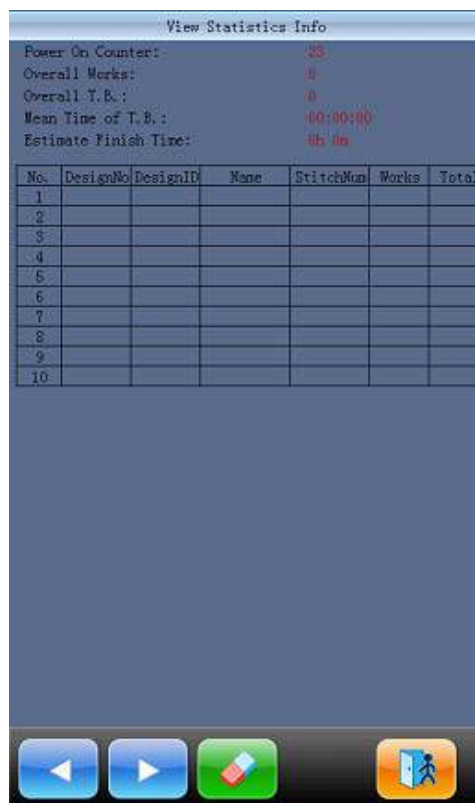

In the above interface, the statistics information is displayed in a chart. The user can click 

to clear the value and click  to return.



10.3 Set Frame Origin/ Power-off Protection

Setting the frame origin point is the premise for saving the design's start point and setting frame protection at sudden power-off. So after the installation or maintenance of machine, it's necessary to set the frame zero point or power-off protection.

- 1、 Click  in the main interface to enter the “Other functions” interface.
- 2、 Click “Set Frame Origin”.
- 3、 Users can decide either to use “manual set frame origin” or “auto set frame origin”



System will ask users to make choice. Users can decide either to use “manually set frame origin” or to use “auto set frame origin”.

Before setting the frame origin manually, user can move the frame to the desired origin position, and click the key. Then the system will save the current position of frame as the origin point. When meeting emergency stop due to malfunctions or something unusual such as power off unexpectedly, etc. the machine will cancel the “setting frame origin” function to avoid the mistakes. User should do operation of “manual set frame origin” again, if the frame has been moved after power off, or power is resumed on again after repair.

If you hope the system automatically set the frame origin point, click “Auto set frame origin”, and the system will move the frame automatically and set the zero point according to the limit switch. So please ensure that the limit switch has been installed into the machine and activated.

10.4 Frame Origin Recovery

After power-off, if the frame is moved, this operation can be used to restore the frame position when power resumes. The proper performance of this operation is based on the setting on “Set Frame Origin” (Auto set frame origin). Additionally, when sudden power-off takes place in the process of embroidery operation and the frame has not been shifted, users can directly press the start key to continue embroidering after power resumes.

- 1、 Click  in the main interface to enter the “Other functions” interface.
- 2、 Click “Frame Origin Recovery”

If it is “auto set frame origin”, the machine will automatically move to the frame origin and then back to embroidering position before power-off. It will be invalid if the operation of “manually set frame origin” is done.

10.5 Set Frame Soft Protection

As the basis of the function of “Locate Design to Center”, this function is to set the embroidery range in the software, which is to have machine to embroider within this area.

- 1、 Click  in the main interface to enter the “Other functions” interface.
- 2、 Click “Set Frame Soft Protection”
- 3、 If have already established the software protection, the system hints the customer to clean original constitution.



- 4、 After clicking the confirm key, user can set the coordinate in the top-right corner.



Use the move frame key on panel to move the embroidery frame, confirm the upper-right corner point of soft limit position and click  to confirm it.

- 5、 Move frame, input coordinate of bottom-left corner of soft limit position.



Use the move frame key on panel to move the embroidery frame, confirm down-left corner point of soft limit position and click  to confirm.

- 6、 The system saves embroidery frame software protection.

10.6 Change Language

The system supports Chinese English, Turkish, Spanish and so on

- 1、 Click the “other functions” key  to enter into other functions interface.
- 2、 Click the shift key to change language.

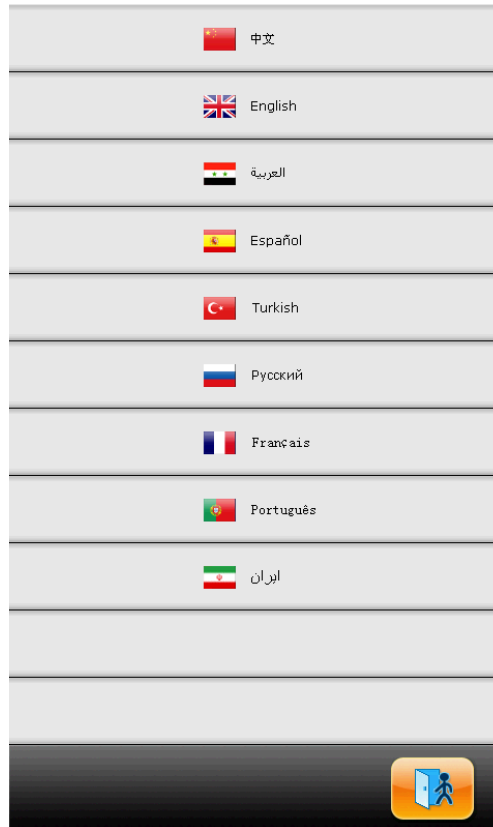

Click the language you want; system will go to the language changing interface.

10.7 Machine Authorization Management

Note: The section is fit for the machine having password-protected function.

For a convenient machine management, the common user can't have access to the setting of all parameters; the roles of the customer are divided into the common user, machine administrator and factory customer. The authorization of the common user is the lowest, they can only modify the embroidery parameters, machine administrator can modify the management parameters along with the embroidery parameters, but the factory user can modify all the parameters.

Click the authorization management key, the system will display the authorization management interface.



If machine administrator or the factory customer need modify the parameters after setting the password, they must input the password first, and then they can change the parameters. They can also change the password, save or recover the parameters here.

10.7.1. Disable/Change Admin Password

When machine come off the production line, the entire parameters of it are unlocked. At this moment, users can modify all the parameters and machine administrators can modify the password. After the password is changed, general users can't modify the machine application parameters. Administrator must relieve system lock so that he can modify the password.

- 1、 Click  on the main interface to enter the other functions interface.
- 2、 Click “Disable/Change Factory Password”.
- 3、 Input old password and then the new one.



The administrator needs to input the old password and new password that need to be establish one by one in order, the factory will tell the administrator the system default password. The figure number of the new password must be between 4-9. For preventing the mistake operation of customer, the system will request user to input new password twice and without any difference.

10.7.2. Admin Unlock

After machine administrator modifies the password, the machine is locked. General customers can't modify the machine application parameters at this time, and the administrator needs to input password to unlock the system before the modifying the parameters. The machine will be locked after power-on at each time.

- 1、 Click  on the main interface to enter the other functions interface.点
- 2、 Click “Disable/Change Admin Password”.



System will ask users to input password.

3、 Administrator input password

After administrator inputs the password, the system will be unlocked. Then customers can modify the machine application parameters.

10.7.3. Save/Recover Admin Optimum Parameters

Procedures:

1. Save Admin Optimum Parameters

- 1) At main interface, press " " to enter the machine parameter management interface.

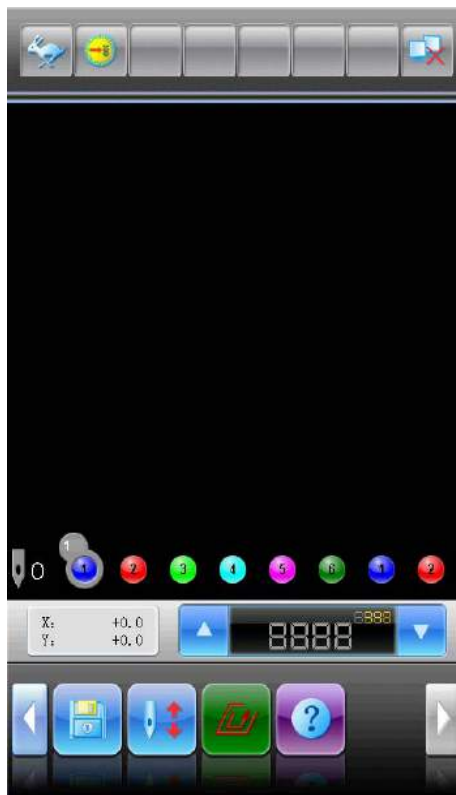



2) Click "Machine Authorization Management " .



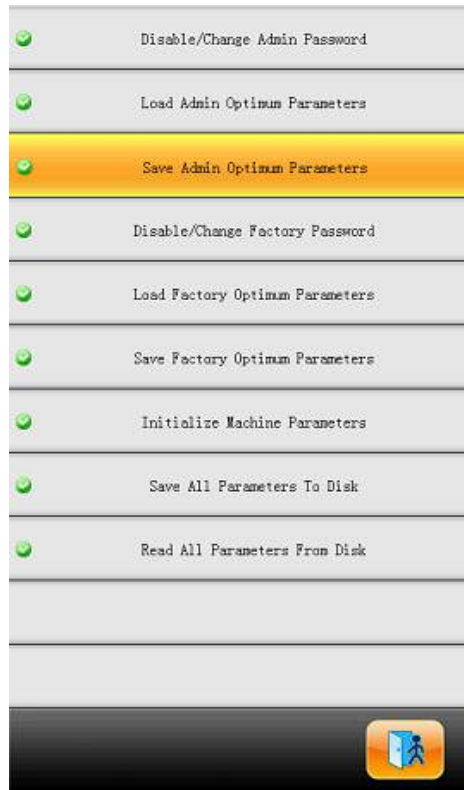

3) Click "Save Admin Optimum Parameters "



4) When system asks "Save the admin's machine parameters?", please press "  ".

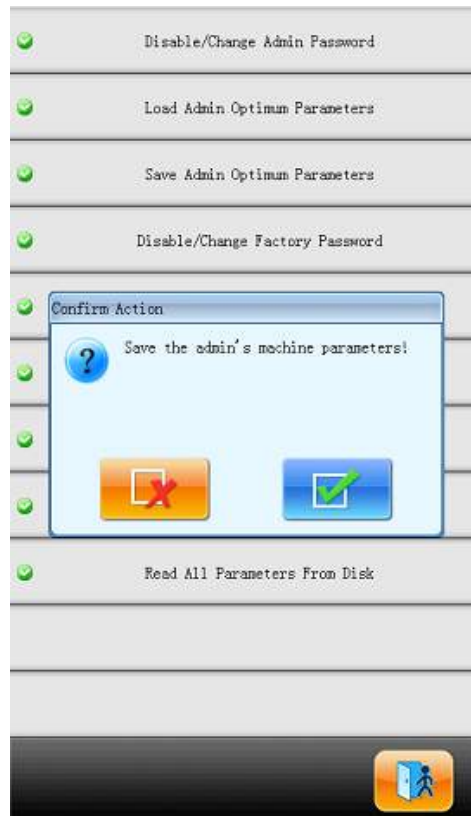

After above operations, the Admin optimum parameters will be saved. For recovering the admin optimum parameters, user needs follow the procedure at below.

2. Recover Admin Optimum Parameters

1) At main interface, press " " to enter the machine parameter management interface.

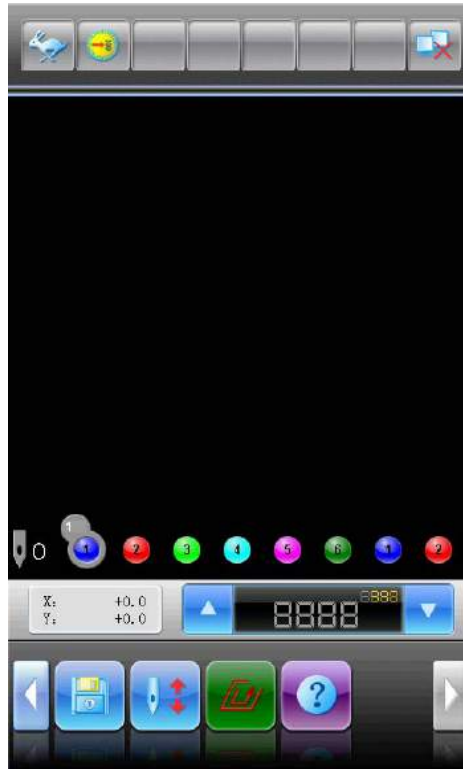

2) Click "Machine Authorization Management ".



3) Click "Recover Admin Optimum Parameters".



4) When system asks "Recover the admin's machine parameters?", please press



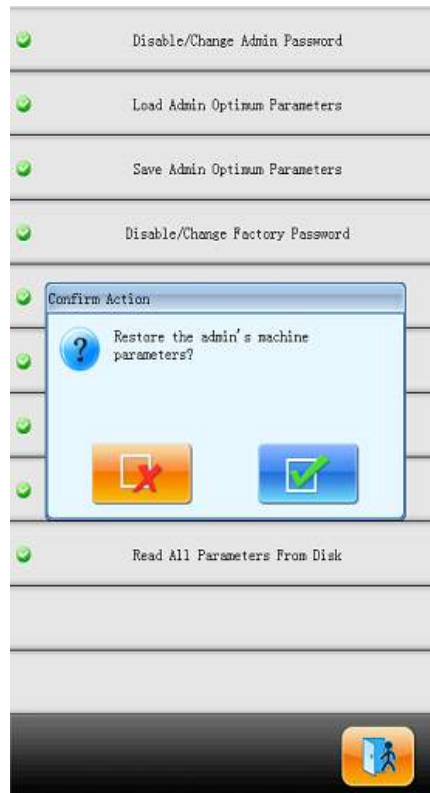

After the above operations, the values of the basic parameters of machine will be recovered to the original status, and the machine can work normally again.

10.7.4. Change Factory Password

Machine factory customers can modify all the parameters. When machines get off the production line, the machine is in unlocked status. Customers can change the password. Machine will be locked after the password is locked. If you want to change the parameter, you should unlock the password at first. Attention: If you repower the machine, machine will be locked again. The detailed operations are similar to those in “Disable/Change Admin Password”.

10.7.5. Factory Unlock

Operations of this function are similar to “Admin Unlock”

10.7.6. Save/Recover Factory Optimum Parameters

Procedures:

1. Save Parameters:

1) At main interface, press "" to enter the machine parameter management interface.

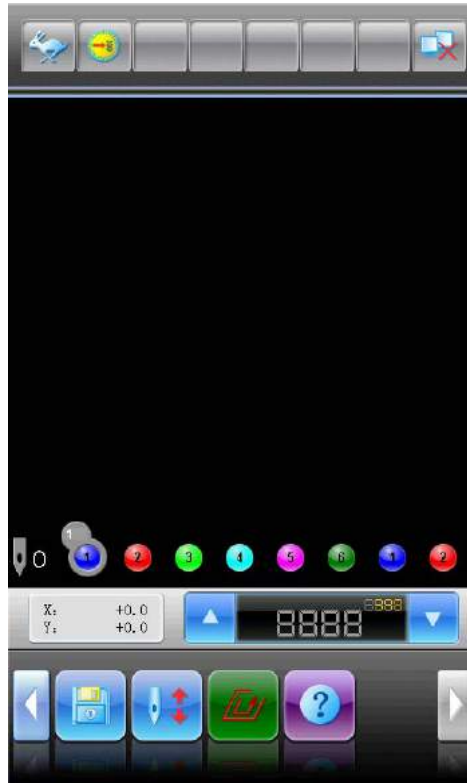



2) Click "Machine Authorization Management".



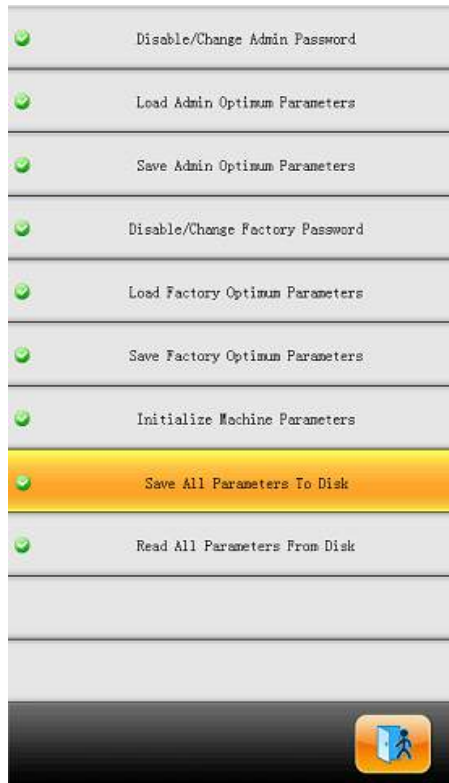

3) Click “Save All Parameters To Disk”



4) When system says "Insert Disk To Save All Parameters", please insert the USB and then press "  ".





5) When system displays “Success to save all parameters to file "DH-PARAM.TXT”, the update is successful.

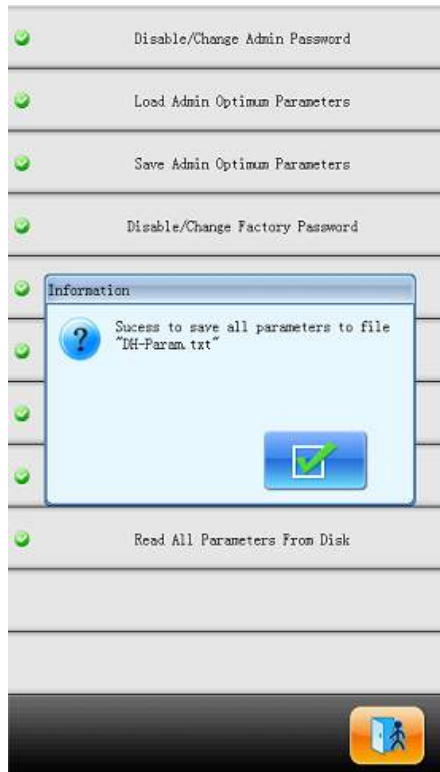

After the above operations, user can update the machine. After the update, user needs to repower the computer. After the initialization of system, the parameters are be recovered.

2. Recovery of Parameters after Update

1) At main interface, press " " to enter the machine parameter management interface.

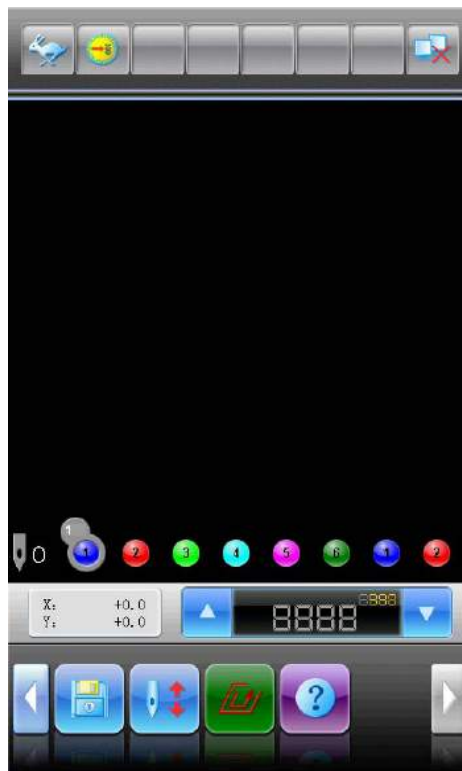

2) Click "Machine Authorization Management ".





3) Click “Load Parameters From Disk”



4) When system says "Insert Disk To Load Parameters", please insert the USB and then press "".

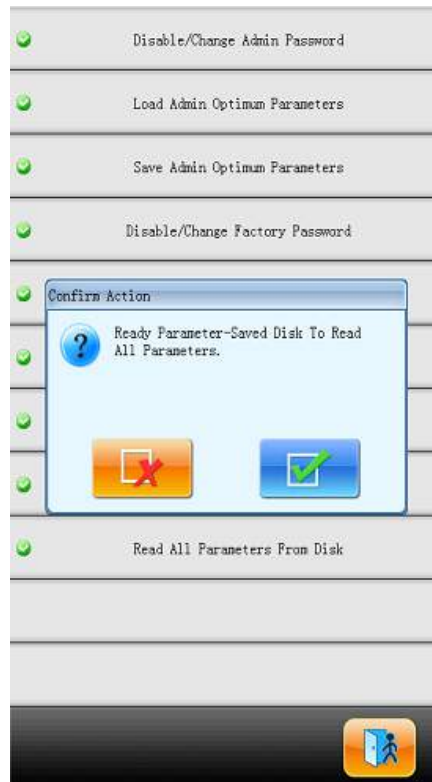



5) When system displays "Fail to read all parameters, file not existed or changed.", the loading is successful.

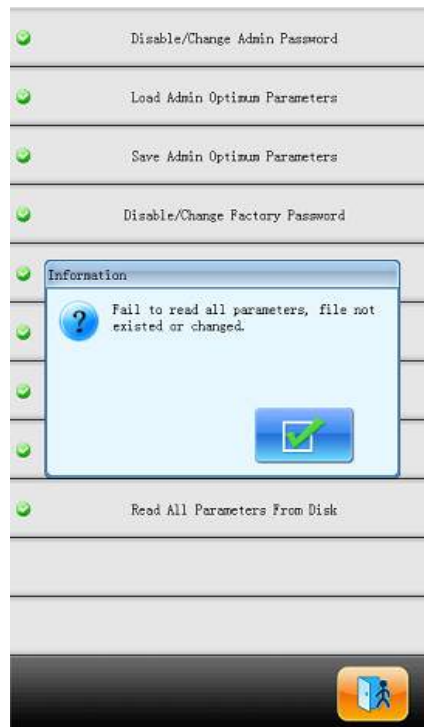

After the above operations, the value of the basic parameters of the embroidery machine will be recovered to the status before the update, and the machine can be used normally.

10.7.7. Initialize Machine Parameters

This function can initialize the general embroidery parameter of the machine. In the system, there is a group of value saved as the default parameter value; the factory and embroidery factory administrator can save corresponding parameter that they managed. When user activate this function to initialize the parameter, please follow the rules at below:

- 1、 When the factory password and embroidery factory administrator password were not established, the initialization will turn the general embroidery parameters to their default values that were saved by system.
- 2、 If the factory password had already been established and decoded, the initialization would turn the general embroidery parameters to their default values that were saved by system.



- 3、 If the factory password had already been set (but hadn't been decoded), and the embroidery factory administrator password had been decoded (or had not been set at all), the initialization would turn the machine parameter managed by factory to value saved by factory, the other parameters would be turned to default value saved by system.
- 4、 If the factory password had been already set (but hadn't been decoded), and the embroidery factory administrator password had already been set (but hadn't been decoded), the initialization would turn the machine parameter managed by factory to value saved by factory, the machine application password managed by the administrator to the values saved, and the other parameters would be turned to default value saved by system.
- 5、 If the factory password had not been set and the embroidery factory administrator password had already been set and decoded, the initialization would turn the entire general embroidery parameter to the default value saved by system.
- 6、 If the factory password had not been set and the embroidery factory administrator password had already been set (but hadn't been decoded), the initialization would turn the machine application password managed by the administrator to the values saved by the administrator, and the other parameters would be turned to default value saved by system.

10.8 Machine Information

Operation Procedures:

- 1、 At main interface, press " " to enter the machine parameter management interface.
- 2、 Click "Machine Info"



This function will help users to check u machine software information. Click  to exit.

10.9 Debugging Machine

 *This operation is only for the repairman, the ordinary operators are banned to use these operations. Because these operations involve some mechanical works, please attach attention to the personal safety and equipments security at operation.*

Adjustment function is to mainly used at Test of machine, Maintenance of machine and Problem-checking, which include the following function: (for the different model, the debugging item will be different)

- Test Encoder
- Test Main Speed
- Turn Main-shaft from 100 to Certain Degree
- Test Pull Bar
- Test Limit Switches
- Test Head Solenoids
- Test Trim Solenoids/motor
- Test Thread-holding Solenoid
- Open Trimmer to Certain Angle
- Test Trimmer
- Trim Motor Search Origin



Test Thread-breakage Detection

Test Needle Position

Test Upper Thread-holding

Test Sequin Device Action

Test Zigzag Motion

Test Taping Presser Action

Debug Sequin Device

Test Touching Panel

10.10 Date and Time

In date and time interfaces, the customer can check and modify the date and time in system.

10.11 Touching Panel Correction

After using for a period, the touching panel may probably have the problem of the inaccurate operation. This problem can be resolved with the function of the touching panel correction. During the correction, please touch the very center of the cross displayed on the panel, or it may cause the operation in future. In order to avoid the trouble caused by the inaccurate correction, this operation is only for the person with the authorization.

- 1、 Click  on main interface to enter other functions operation interface.
- 2、 Click Touching Panel Correction
- 3、 If the machine have password-protected function and has been set password, please input admin password or factory password. If not, please go to Step 4.
- 4、 Click the center of the crosses one by one.

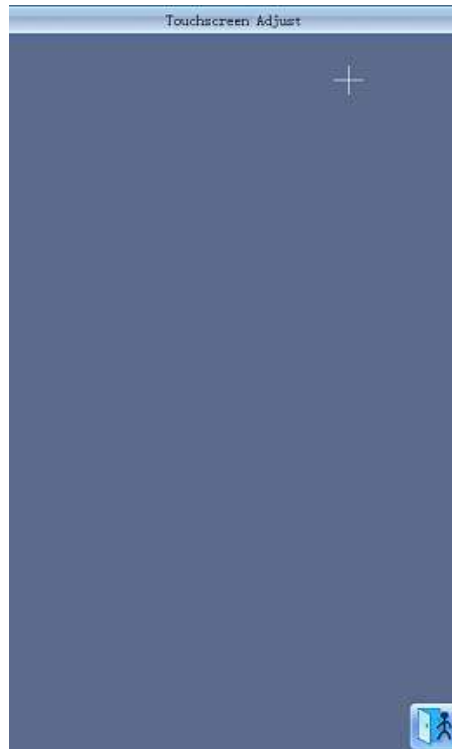

During the process of correction, a lot of crosses will appear on the screen. Users should click the center of them. System receives the data of those points and saves them as standard data for correction. Click  to exit.

5、 System will make adjustments according to the coordinates of points clicked by customers.

System will make self-adjustments according to the point clicked by customers, and then the system will return to “Other Functions” interface.



Chapter 11 About JF Sequin Embroidery

11.1 Brief of Sequin Embroidery

Sequin embroidery is formed by many sequins and the specific stitch form. Because the sequins are made of the hard and shining material with smooth surface, the sequin embroidery, formed by the sequins with different colors, shapes and sizes, features the unique shining effect. The design with sequin code has its own pattern format.

JF Type multi-sequin embroidery is divided into two types on the designs: one is normal multi-sequin design, made by the traditional pattern-making method; the other is special multi-sequin design, made by the normal design software with the special pattern-making rules.

For normal multi-sequin design, user should set sequin mode when modifying the color-changing order. But the special multi-sequin design can be directly embroidered only after modification of color-changing order, which means user doesn't need to set the sequin mode.

Meanwhile, the machine can automatically change normal design to special design during the process of design import. The new special design saves the entire sequins in the original normal design as sequin A. If you want further modification, you can use "Sequin Edition" to modify. The multi-sequin design after the modification is the special multi-sequin design.

Remarks: For the special pattern-making rules, please refer to Appendix 4 Method for Making Special Multi-sequin Design.

I . Application Range

This system is applicable to the sequin embroidery control system that combines normal embroidery mechanism, zigzag embroidery device and sequin-feeding mechanism.

II .Features

1、 Support two sequin-feeding method: Wheel and Lever;

Wheel: The core part for feeding the sequins within this device is the mechanism like a wheel, which transports the sequins to the proper position by rotating in the single



direction.

Lever: The core part for feeding the sequins within this device is a lever mechanism, which will send the sequins to their positions with its alternating motion.

- 2、 Separate action of sequin-mending and sequin-feeding device;
- 3、 Manual separate or collective feeding at single time;
- 4、 Separate display of the working statuses of sequin device;
- 5、 Sequin-feeding method and the feeding angle can be changed via the operation panel.

III. Specifications

- 1、 Size of Sequin available: Diameters at 3mm, 4mm, 5mm, 6.75mm and 9mm;
- 2、 Max speed at 850rpm.

11.2 Embroidery Procedure of Sequin

At sequin embroidery, user needs to follow the procedure at below:

1. Input design with sequin code, refer to 11.3
2. If necessary, please transform and edit the design, please refer to 11.4);
3. Set the sequin parameter according to the setting instructions in 11.5.
4. Check and adjust the sequin-feeding device (Refer to 11.8), so as to make sure the sequin-feeding device works normally;
5. Set color-changing order (Refer to 11.6)
6. Return to main interface and confirm the embroidery;
7. Start embroidery.

Attention: during the embroidery, don't dial the manual switch for moving the valve, or it will cause the damage of the sequin-feeding device.

11.3 Input Sequin Design



Press  in the main interface to enter disk selection interface to open the disk



needed. After selecting design for input, user needs press  to have access to the design

input interface as shown in below:



Data Input	
New Design number: 11 <1, 400>	
New Design name: FANG_JP	
Is Multi-Sequin Design?: No	

abc [Red Arrow]

0 1 2 3 4

5 6 7 8 9



[Green Checkmark] [Red X]

Setting procedures: User should input number and name of pattern. In the column of “Is multi-sequin design”, user needs select an import way. Choosing “Yes” is to save it as the special sequin design no matter what is was. For the normal sequin designs, the changed sequin designs will save all the multi-sequin within the original design as “A” type sequin. If you choose “No”, normal sequin designs remain as they are, while special multi-sequin designs will be saved as special multi-sequin design.





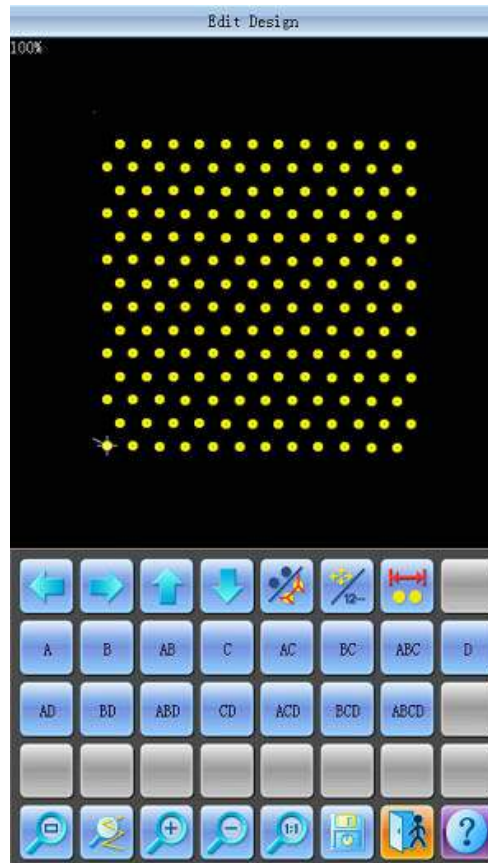

11.4 Edit Sequin Design

This function is to edit sequin design within the system. After edition, all the designs will be saved as special multi-sequin design. User doesn’t need set the sequin mode at modifying the color-changing order





1. Press  in the main interface to enter the “Design Management” interface
2. Press direction keys to select sequin design for edition. Click “”, “Edit Design”, “Edit Sequin Setting of Current Design” in order to enter the “Edit Design” interface.

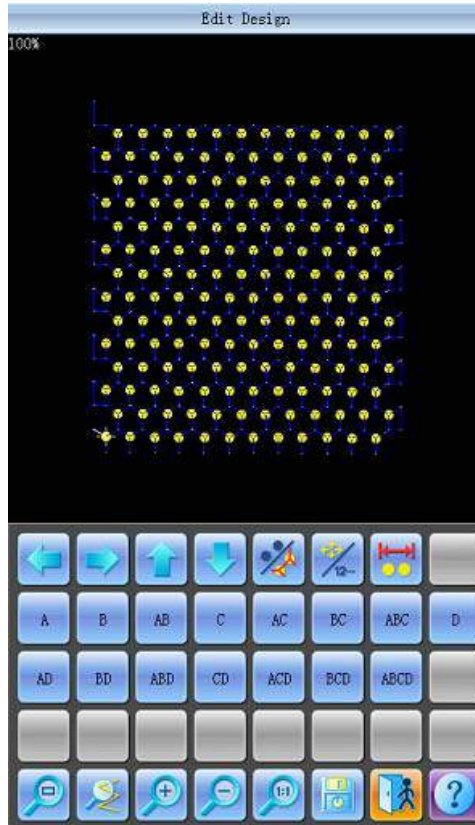

3.  Display design in the center;  Display design 4.5 times as original one;  Zoom in sequin design;  Zoom out sequin design;  Display in original size
4. Click  to show all stitch forms of the design, as shown below:



5. Click  to shift the current stitch mode between “navigating by position” and “navigating by stitch number”. “navigating by position”: when you press direction keys, the next stitch code in that direction will be selected, regardless at its stitch number. “navigating by stitch number”: when you press direction keys “leftward” or “upward”, the last sequin stitch code (smaller than the current number) will be selected; when you press “rightward” or “downward”, the next sequin stitch code (bigger than the current number) will be selected.

6. Click  to enter into “Sequin Range Edit”.



- (1) Move the cursor to a stitch position, then click “Set Range Start Stitch” to set the current stitch as the start stitch of this area. Move the cursor to a different stitch position, then click “Set Range End Stitch”. The area for setting is from the start stitch to end stitch.
- (2) If you want to cancel the area, click “Cancel Range”.



7. Sequin Mode Selection

There are 15 kinds of sequin modes for customers to select, including A, B, AB, C, AC, BC, ABC, D, AD, BD, ABD, CD, ACD, BCD and ABCD.

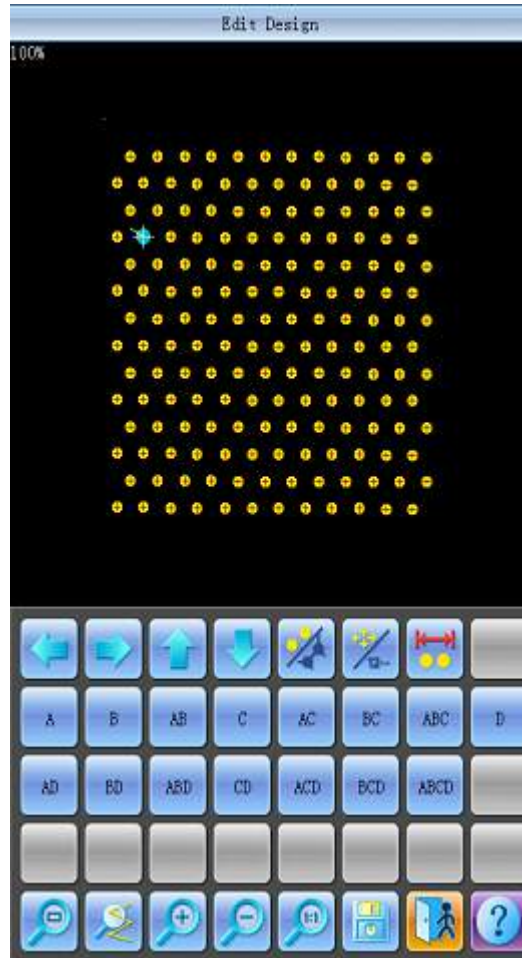
Names of these 4 sequins: A, B, C and D. If these 4 sequins are delivered at same time, then A will be on the top, then B, C and D.





8. Edition of Alternating Sequin

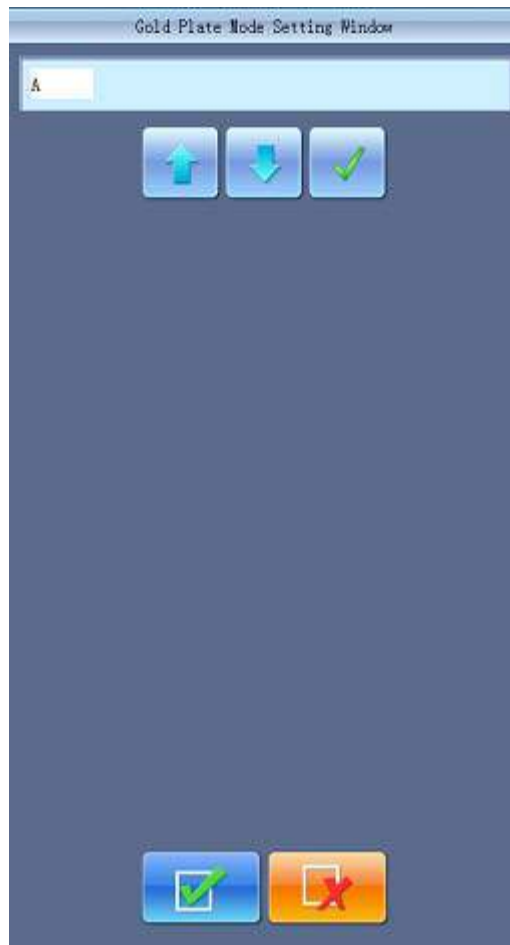

If you want to use the alternating sequin, you should define a range for using them at first. In “”, use “Set Range Start Stitch” and “Set Range End Stitch” or “Select Current Color Range” to set sequin range. After that, use “Edit Alternating Sequin” in “” to set the alternating sequin used.





Setting method:

- a) Click  or  to select sequin mode and click  to confirm.

Sequin names are A, B, C and D. If all these four sequins are included, A will be on the top, then B, C and D.

- b) After that, press  to confirm the sequin-feeding mode. Then the system will ask user to input the number of sequins fed. Click the number keys to input the number (Range: 0~9999). If a sequin group is only used for one stitch at the embroidery cycle, user will need to input “1” and then press .

- c) Click  or  until you see “END” in the blank or the feeding number becomes “0”. Press  to finish the setting.

For instance, if the current sequin mode is A2ABCD1CD1, the design will be like the one at below:

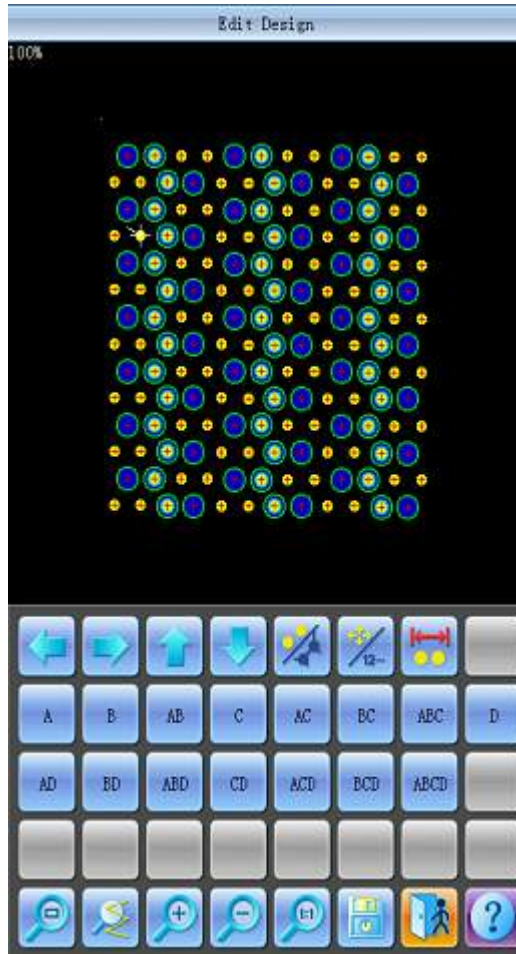

9. Save

When you finish the edition, click  to save the design.



Edit Sequin of Current Design

New Design number:	12
New Design name:	FANG_IP

<1,400>

abc|

0 1 2 3 4

5 6 7 8 9

✓ ✗

Input design number and name, then click  to save the edited sequin design, or click  to cancel the saving.

11.5 Setting of Multi-Sequin Embroidery Parameters

In this section, we will introduce how to adjust sequin device and the parameters used in multi-sequin embroidery.

Select  in the main interface to enter parameter management interface, then select

Sequin Parameters to have access to the interface for setting the sequin parameters.

1、 Limited Speed for Sequin R(L):

The parameter is to set the max speed during normal embroidery.

Note: the maximum speed of flat embroidery should be higher or equal to speed for sequin embroidery.



2、 L/R Sequin Feeding Angle Adjustment

This parameter is to adjust the sequin-feeding angle.

3、 Auto Start for Sequin

When the setting is “Yes”, system will start embroidering sequin automatically.

When the setting is “No”, machine needs manually start at sequin embroidery.

4、 Time of Sequin Action

This is to set the time from sequin device going down to starting embroidery (0-15, the default value is 2). If the sequin-feeding device is controlled by valve, use the default value; if that device is controlled by motor, please set it at 4~5.

5、 Sequin off after T.B.

When the setting is “Yes”, sequin presser foot will be up automatically in case of thread-breakage.

When the setting is “No”, the user needs to lift the presser foot manually at thread-breakage.

6、 Sequin Ind. Up/Down

When the setting is “Yes”, the sequin devices will move independently. When the setting is “No”, they will move collectively

7、 Lift Valve at Jump without Trim (Y/N)

8、 Base of Shift Travel at L/R Motor

9、 Multiple of Shift Travel at L/R Motor

10、 Has Origin at Shifting L/R Motor

The parameter No.8, No.9 and No.10 are for the special sequin device that uses the motor (Single Needle Double Sequin) to shift the travel between large sequins and small sequins. There are two kinds of device: one has the shift origin; the other has no shift origin.

11、 L/R Trimmer Action Angle Adj.

This parameter is used at the special sequin device that uses motor to cut the sequin for adjusting the start time of the sequin-cutting motor. The default value of it is 15. The smaller value means the earlier action of motor, the range of this value is 0~31.



12、 Beam-breakage Detection Sen.

This parameter is used for the beam embroidery device. “0” is to turn off the sensitivity, the range of this parameter is 0~10. The smaller value means the higher sensitivity of the detection device.

13、 Motor Number of L/R Sequin

The setting of this parameter should be based on actual device condition, if there is no sequin device, please set it at 0.

14、 Set 3/4/5/6.75/9mm of L/R Sequin

This parameter group is to set the sequin delivery angle. If it is wheel type sequin-feeding device, please set it at single way; if it is lever type sequin-feeding device, please set it at double ways. The parameters of this type are set correctly when the machine is produced. This kind of parameters is closely related to “left/right sequin device A/B/C/D size and color”. For example, “A size&color of R sequin” is set to “4mm X color”, and then the angle value should be the one in “Set 4MM of R Sequin”.

15、 A/B/C/D Size &Color of R/L Sequin

The setting of this parameter should depend on the mechanical structure. The corresponded order from A to D is front motor to back motor.

Note: “Motor Number of L/R Sequin” is closely related to the number of A/B/C/D in “A/B/C/D Size&Color of R/L Sequin”. For example, if “Motor Number of L/R Sequin” is set to 2, then only the “A/B size&color of R/L sequin” will be displayed.

16、 Sequin Gap Num. of L/R Sequin



This is to set gap number. If there is no gap, then it should be set to 0.

17、 L/R Sequin Valve Action Time

This parameter is for setting the response time at adjusting the valve action. The larger value means the longer response time. Please set it according to the actual condition of device. Default value of it is 2.

11.6 Change Color Order and Set Sequin Mode

User must set sequin mode at setting color-changing for the normal multi-sequin design; but for the multi-sequin design, user only needs set the color-changing order. The operation procedure is at below:

1. Click  in the main interface, then click “” to enter color-changing order interface.

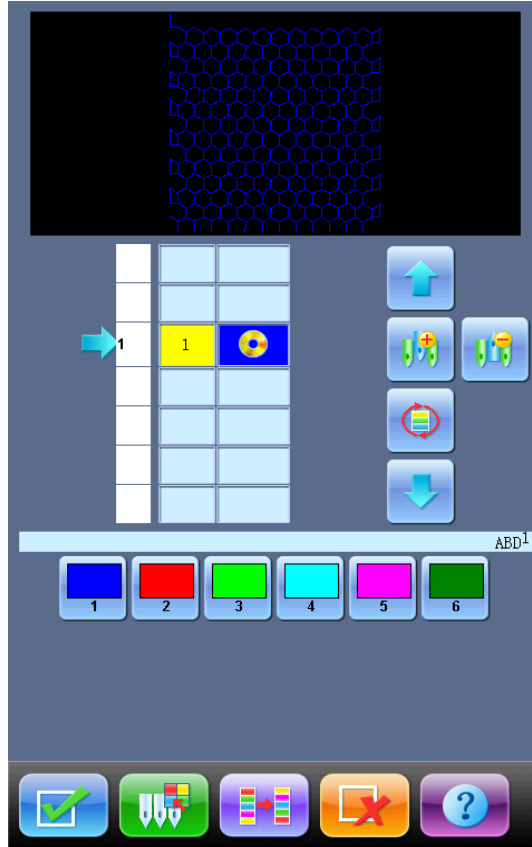

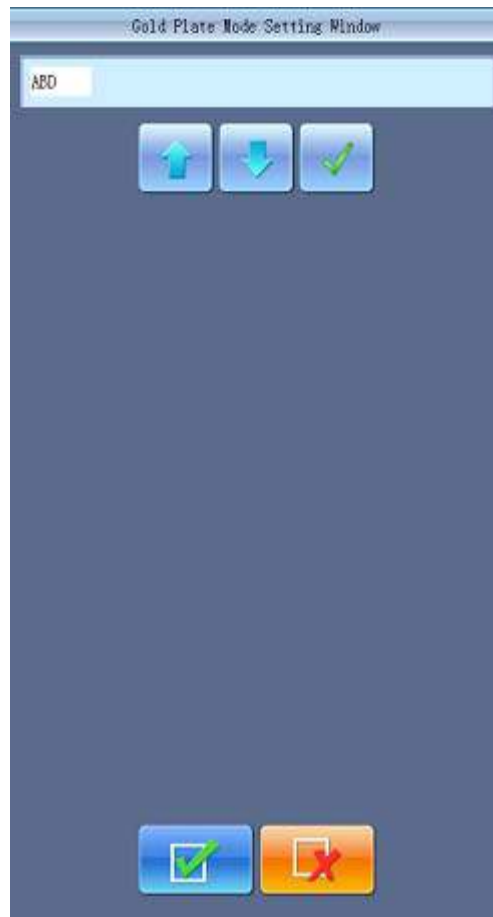

2. Click number key to set color-changing position. If the first/last needle position is the multi-sequin device. After user clicks that key, the system will ask for setting the sequin delivery mode; if the device is single sequin device, or the design is special multi-sequin design, it will be no need to set sequin delivery mode. For example, the last needle is needle 6, click “6”, then you can see:





Procedure for Setting Sequin-feeding Mode:





- a) Press number key to confirm embroidery needle position. The needle position equipping sequin device will display “Sequin Mode”;

- b) Use  or  to modify the delivery mode and press  to confirm. A stands for front motor delivery; B stands for middle motor delivery and C stands for rear motor delivery. AC stands for front/rear motor overlap sequin, AB stands for front/middle motor overlap sequin, BC stands for middle/rear motor overlap sequin and ABC stands for front/middle/rear motor overlap sequin;

Note: if there are only two motors, B will stand for rear motor.

- c) Press  to make sure the sequin-feeding method. Then input the number of sequin for feeding (Range: 0~9999). If it requires same mode before color-changing, then type in “1” and press .





- d) Use  or  until you see “END” in “Sequin mode”, then press  to confirm and save the settings. Clicking  is to keep the sequin mode before the edition.

For example: a machine with needle No. 9 as its end needle (tri-sequin at 3, 5, 7mm); first needle is single sequin (9mm). The requirement is 7mm at first, then 3 & 5mm overlap, then 5 and 7mm alternate embroidery, then sew 9 pieces of 3mm, 8 pieces of 5mm, 4 pieces of 7mm, 6 pieces of 3 & 7 overlap sequins, at last, use first needle to embroider 9mm sequins



Procedure of Setting:

(1)

① Click 9 to activate the interface for setting sequin-feeding mode;

② Click  or  until “C” appears, then click ;



③ Click “1”, then click ;

④ Click  or  until “End” appears, then click  to finish the first



setting.

(2)

① Click 9 to activate the interface for setting sequin-feeding mode;



② Click  or  until “AB” appears, then click ;

③ Click “1”, then click ;

④ Click  or  until “End” appears, then click  to finish the setting.







(3)

① Click 9 to activate the interface for setting sequin-feeding mode;





















② Click  or  until “B” appears, then click ;

③ Click “1”, then click ;



- ④ Click  or  until “C” appears, then click  ;
- ⑤ Click “1”, then click  ;
- ⑥ Click  or  until “End” appears, then click  to finish the setting.

(4)

- ① Click 9 to activate the interface for setting sequin-feeding mode;
- ② Click  or  until “A” appears, then click  ;
- ③ Click “9”, then click  ;
- ④ Click  or  until “B” appears, then click  ;
- ⑤ Click “8”, then click  ;
- ⑥ Click  or  until “C” appears, then click  ;
- ⑦ Click “4”, then click  ;
- ⑧ Click  or  until “AC” appears, then click  ;
- ⑨ Click “6”, then click  ;
- ⑩ Click  or  until “End” appears, then click  to finish the setting.
- (5) Click “1”, then click  to finish the setting of the color-changing

Note: if it is single sequin, directly click needle position number.

11.7 Manual Operation of Sequin Embroidery

The manual operation part contains “Sequin Start”, “Sequin End” and “Sequin-feeding”.

- (1) In the main interface, click  one by one, then select “sequin start” to let all the presser feet get down;

(2) In the main interface, click  one by one, then select “sequin end” to lift all the presser feet;

(3) In the main interface, click  one by one, then select “send sequin”; the activated machine heads will send a sequin at each clicking (with presser foot at down position).

11.8 Debugging Multi-Sequin Embroidery

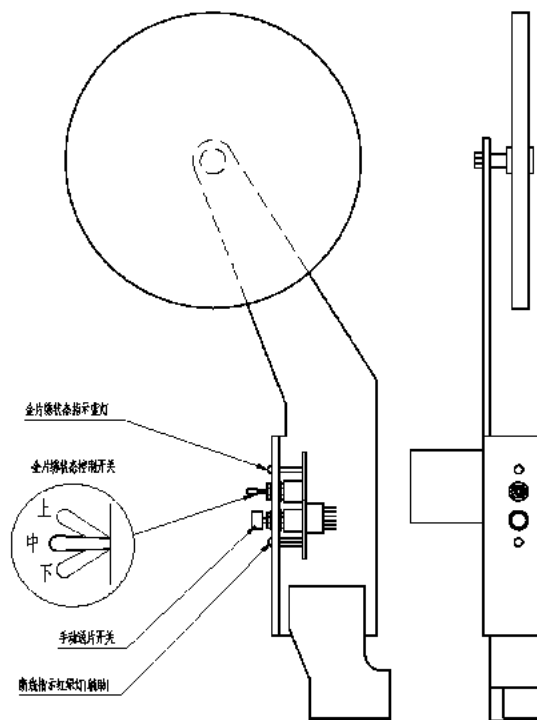

Location of Sequin Switch Board

1、Operation of Sequin Switch

(1) Manual Operation for Front Motor Sending A Sequin

Put the sequin switch to the down position, dial the thread-breakage detection switch to turn on the green indicator and press manual sequin-feeding button.

(2) Manual Operation for Middle Motor Sending B Sequin

Put the sequin switch to the down position, dial the thread-breakage detection switch to turn on the red indicator and press manual sequin-feeding button.

(3) Manual Operation for Rear Motor Sending C Sequin

Put the sequin switch to the down position, dial the thread-breakage detection switch to turn off the head indicator (dial it to down position too) and press manual sequin-feeding button.

Note: In order to debug the multi-sequin function, user needs to install an external head switch on the single head machine.

2. Debugging Menu of Sequin

Press  in the main interface, then press “machine debugging”. Then press “Sequin

Device Operations” to show the following image::



Then you can select related operation for debugging.



11.9 Sequin Mending

After the thread breaks or the red thread-breakage detection indicator is turned on manually, press the stop key to retreat and have the system enter the mending status. At mending status, the sequin devices will go up and the machine will return and stop at the mending point. Then user can press the Start key to perform the mending embroidery for sequin. The mending embroidery will turn to the normal embroidery at the thread-breakage point. Among the machine parameters, the “Patch Count” is unavailable in the in sequin mending operation.



Chapter 12 Operation of Zigzag Embroidery

12.1 Functions

- 1、 Zigzag Embroidery (ZIG Embroidery): this function is to make the thread form the design with certain stitch forms, which have been saved in the computer in advance, the Z4 and Z5. The figures of these two kind of ZIG embroidery are shown at below:



Z4 Embroidery



Z5 Embroidery

- 2、 User can set the max speed for flat embroidery and the top speed for zigzag embroidery respectively.
- 3、 Auto saving of the stop point of the M axis: M axis will return to the stop point when the power resumes.
- 4、 Thread-trimming for Zigzag Function (Trim bottom thread Only)
- 5、 Before manual frame-moving, the zigzag device can lift the presser automatically, while it can also lower the presser before the embroidery.

12.2 Key Technical Indexes

- 1、 Speed of Zigzag: 300~1000rpm, unit: 10rpm.
- 2、 M Axis Manual/ Auto Rotation Step: 18° /Step.

12.3 Procedure of Zigzag Embroidery

- (1) Input zigzag embroidery design, then select, adjust and edit the design according to needs;
- (2) Change parameter, select color-changing order and decide embroidery mode;
- (3) Check zigzag embroidery position, and make sure it works normally;
- (4) Start Embroidery

12.4 Related Parameter and Setting Mode

Click parameter setting key  in main interface, then user can set the parameters

relating to the zigzag embroidery.

1. Right Zigzag Device: Y (N) —— Y means the first needle is the zigzag embroidery position.



2. Left Zigzag Device: Y (N) — Y means the last needle is the zigzag embroidery position.
3. Zigzag Device Move Time: 2 (Default Value) — User should set this value according to the actual action time of zigzag device.
4. Swing Range of Zigzag: 100 (Default Value). This value is the rotating angle of the wheel. At the circumstance of thread-floating, user can decrease this value to relax the influence as an assistant method. Generally, this value should be no less than 80.
5. Top Speed of Zigzag: 600 (Default Value). The top speed can be set to 1000rpm, but user needs set it on basis of the actual condition of machine.
6. Frame Swing of Z5 Embroidery: by adjusting the frame, user can change the embroidery range (The senior users are recommended to use this parameter).
7. Thread-loosing Motor for Zigzag Embroidery: Yes/No. if the device is double motor taping device, user needs to set it at “Y”, or user should set it as “N”.
8. Zigzag Thread-loosing Adjustment Value: this is to adjust the thread-sending speed of all the thread-loosing motors. The recommended value is 9.
9. Zigzag Right Device Origin: this is for the angle between the threading point and the direction of the mechanical origin of zigzag device at first needle position. Angle = Parameter value *0.9. For an example, the parameter value is 80; the angle will be $80*0.9=72^{\circ}$.
10. Zigzag Left Device Origin: this is for the angle between the threading point and the direction of the mechanical origin of zigzag device at last needle position. Angle = Parameter value *0.9. For an example, the parameter value is 80; the angle will be $80*0.9=72^{\circ}$.
11. Zigzag Device Movement Detection: Test whether the device moves to the proper position. User needs set this parameter according to the actual condition of the device.
12. Test Thread-sending Motor of Zigzag Device (Y/N): The default value is “Y”. “Y”: the thread-sending motor will not rotate until the position of hall component is checked. “N”: The thread-sending motor will run as long as the system is at embroidery status, regardless the position of the hall component. It can only be used at the “107-P03-1.0” and higher version (for PC107 Board) or the “107B-JY-1.0 & 107B-DB-1.0” and higher version (for PC107B Board).





12.5 Relative Operations of Zigzag Embroidery

12.5.1. Shift between Flat Embroidery Position and Zigzag Embroidery Position

(1) Manual Shift

In the main interface, press the key  to enter into color-changing interface.



“1” is for zigzag embroidery, others are for non-zigzag embroideries. Press the number to activate the corresponding needle position. Press to  exit. The  indicates the embroidery mode of the current zigzag embroidery. Click that key to change the embroidery mode. If user has nothing to change, please press  to exit.

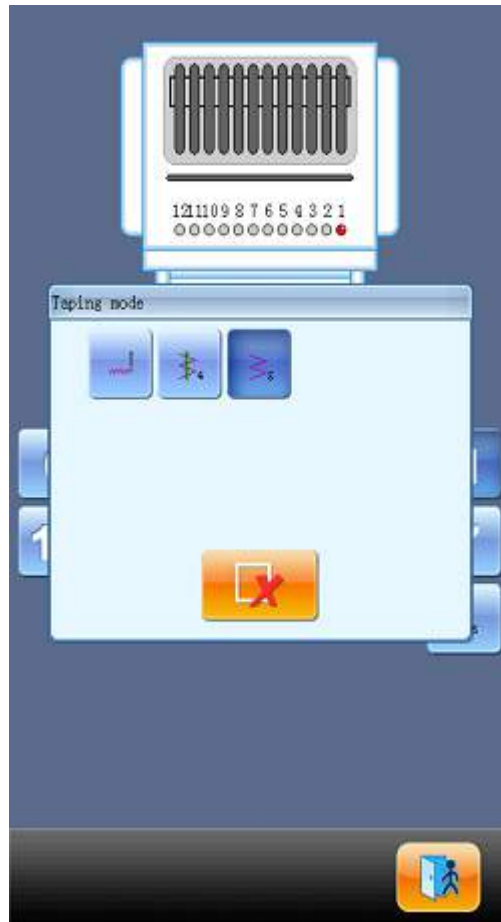

Definition of icons:

 Normal Embroidery;



 Z4 Embroidery: The rod swings at each stitch.

 Z5 Embroidery: The feature of it is same to Z4. It is suitable for the thick thread.

(Refer to the parameter: Swinging scope of frame in Zigzag sewing)

(2) Automatic Shift

Before embroidering, automatic shift can be achieved through setting the color-changing position.

In the main interface, press , and then select “” to enter into color changing

interface, and then press the key  (zigzag head) to change zigzag embroidery mode:



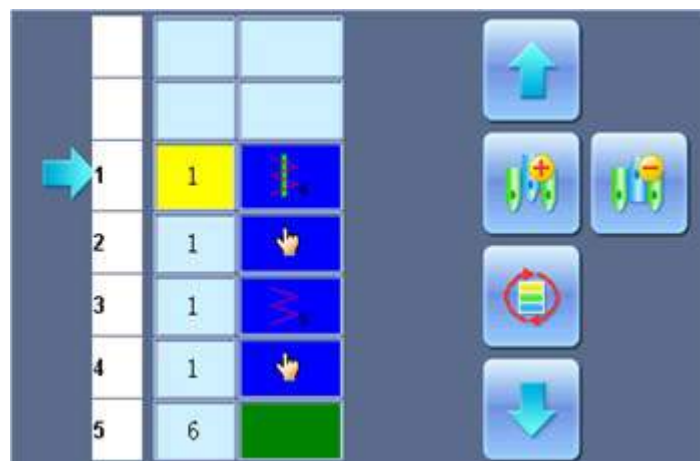

Press the corresponding icon to select the very zigzag embroidery mode, if you don't want to

change, and then press  to exit. After confirmation of the embroidery mode and the setting of color-changing order, the system will display as below:





The icon  means the manual shift status. But the setting in  will still be in effect when system is in automatic shift state.



12.5.2. M Axis Operation of Zigzag Embroidery

The operations about M axis contain “M axis to be ready”, “M axis to cycle” and “M axis to turn”, which are all in the Assistant Functions. In the main interface, you can click





to enter into the “Assistant Operation” interface. Turn the page, then you can see the parameters “M axis to be ready”, “M axis to cycle” and “M axis to turn” displayed in order..

(1) Return M Axis to Working Point

Press the key “M axis to be ready” and click  on the dialogue window to let the M axis back to the working point, click  to exit.

(2) Return the M-axis to the Origin Point (Step Moving)

Press the key “M axis to cycle” and click  on the dialogue window to let the M axis rotate to the “Zero point”, click  to exit the operation.

(3) Rotate M Axis Manually

Press the key “M axis to return” and click “turn to left” on the dialogue window to let the M axis rotate to the left. It will rotate 18° left once you click the button. After 20 times click, it will return to its origin; while click “turn to right” on the dialogue window to let the M axis rotate to the right. It will rotate 18° right once you click the button as well. After 20 times click, it will return to its origin; click  to exit.



Chapter 13 Online Update of Main Software

Update Procedure:

13.1 Update of Upper Machine

- 1、 Hold “3” Task Shift key and turn on the machine.





2、 The screen shows the following picture, select the “Updating Data Program”



3、 Select the “Updating from USB”



4、Click “Disk”.



5、Select the software for update after having access to the interface.





13.2 Update of Turn-on Interface

- 1、 Hold “3” Task Shift key and turn on the machine.





2、 The screen shows the following picture, select the “Update Power on Display”.



3、 Select the “Updating from USB”



4、Click “Disk”



5、Select the software for update after having access to the interface.



6、 Press Enter to confirm updating.



7、 The screen will show “Updating Complete , if not others , Pls repower” when finish updating. Please restart the computer.





13.3 LCD Parameter Update

- 1、 Hold “3” Task Shift key and turn on the machine.





2、The screen shows the following picture, select the fifth “LCD Parameter update”



3、System will ask user whether to “Display Supported LCD ID?”



(1) Click  to check the supported LCD type.

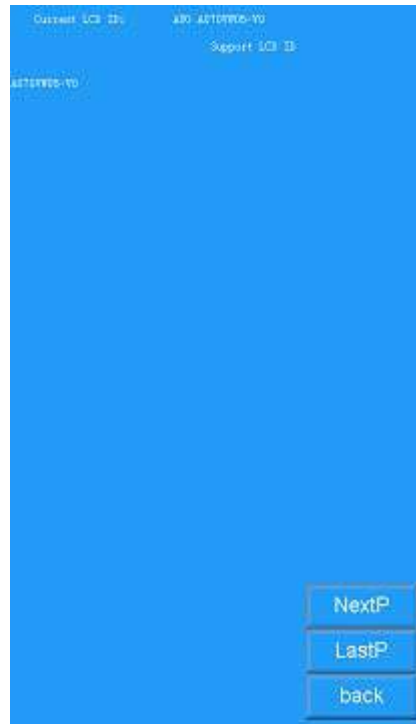

(2) Click  to have access to the interface for selecting update method, select “Updating from USB”





4、Click “Disk”



5、Select the software for update after having access to the interface.



6、 Press Enter to confirm updating.



7、 The screen will show “Updating Complete , if not others , Pls repower” when finish updating. Please restart the computer.



After the update, user needs to initialize the parameters (The “Set Machine Para.” is at the first page of “Assistant Management”.); re-power the computer after the initialization and then reset the parameters.



Chapter 14 Update of Software in Peripheral Board

Update Procedure:

- 1、 Have access to the menu and click .

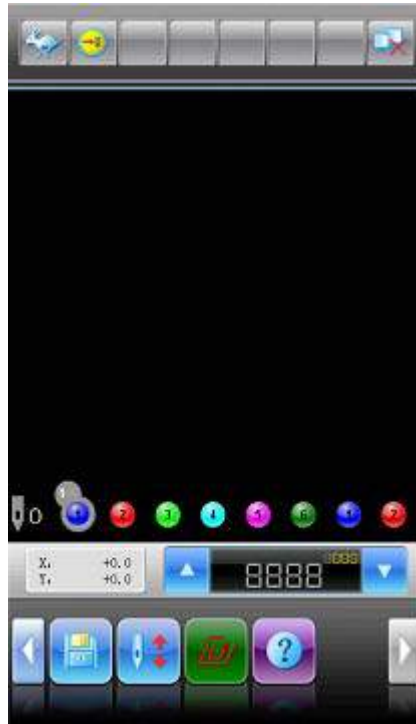

- 2、 Select “Update peripheral board Software”





3、 Input the password and click .



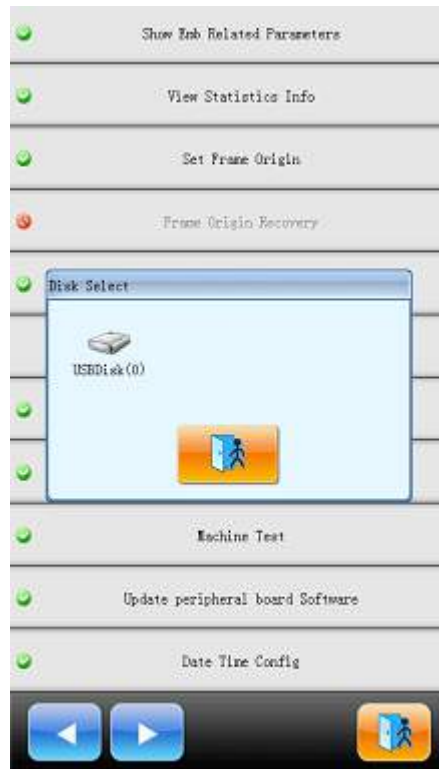

4、 Select “USB Disk”.



5、 Select the program for update and then click .



6、 When system displays “peripheral board program update window”, please click



7、 When system displays “Successful”, the update is finished.





Appendix 1 Parameter List

No.	Name of Parameter	Default Value	Range of Value	Remarks									
Common Parameters													
A01	X&Y Scales	100/100	50%~200%	Scale ratio of design in X /Y direction									
A02	Rotate	0	0~89	Rotating angle of the design									
A03	Direction	P	<table border="1" style="display: inline-table; vertical-align: middle;"><tr><td>P</td><td>a</td><td>d</td><td>r</td><td>q</td><td>σ</td><td>b</td><td>Δ</td><td>p</td></tr></table>	P	a	d	r	q	σ	b	Δ	p	
P	a	d	r	q	σ	b	Δ	p					
A04	Prior Mode	Rotate	Rotate, Scale										
A05	Rep. Mode	Normal	Normal Part	Not used									
A06	Rep. Prior	X Prior	X prior, Y prior										
A07	X&Y Reps	1/1	1~99										
A08	X&Y Interval	0.0/0.0	-999.9~+999.9										
Embroidery Assistant Parameters													
B01	Auto Origin	Yes	No, Yes										
B02	To Do Cyclic Emb.	No	No, Yes	Whether to automatically repeat embroidering the design. It often accompanies repetition or the special design.									
C02	Sewing Empty Stitch	No	No, Yes	If “Yes”, the machine will omit the empty stitches (needle moving without embroidering) so as to avoid the empty stitch. If “No”, the empty stitches won’t be omitted.									
B13	Start for Same Colors	Yes	No, Yes	Whether to start in color-changing way when the later needle position is same to the former one									
C04	Store Manual Color	No	No, Yes	If “Yes”, manual color changing is stored in the color-changing order. After embroidery, the setting will automatically change into “No”.									
D15	Slow STI. After Patch	0	0~500										
B15	Emb Show Background	Yes	No, Yes										
B18	Is Design TrueView	No	No, Yes										



Appendix 1 Parameter List

No.	Name of Parameter	Default Value	Range of Value	Remarks
	Display			
C79	Automatic Jump	No	No, Yes	The same to above
C80	Auto Jump Stitch Len	8.0mm	6.0mm~12.0mm	The same to above
Thread-breakage Detection Parameters				
B05	T. B. Detect	Yes	No, Yes	
B11	Sti. Not T.B. Detect	8 stitch	0 stitch ~15 stitch	
B06	Stop machine after T.B. detect	Yes	No, Yes	
B12	T. B. Detect When Jump	No	No, Yes	
C27	Detect T. B. Mode	Coupler	Coupler, T.B.D Board	
C67	Sensitivity of Upper Thread	6	1~15	
C68	Sensitivity of Under Thread	6	1~15	
C69	Filter Sti. For Upper Thread	6 Sti	1~6 Sti.	
C70	Filter Sti. For Under Thread	6 Sti	1~6 Sti.	
C90	T.B.D Device Type	Spring	Spring, Wheel, Spring+Wheel	
Frame Parameter				
C06	Frame Curve & Angle	F6/230	F1/230,240,250,260,270 F2/230,240,250,260,270 F3/230,240,250,260,270, 280,290 F4/230,240,250,260,270, 280,290 F5/230,240,250,260,270, 280,290 F6/230,240,250,260,270	F2 and F4 are frame curve. The later values are the angles of frame acting.



No.	Name of Parameter	Default Value	Range of Value	Remarks
			280,290	
B03	Over frame by Step	No	No, Yes	
C15	High Frame-Shift Speed	16	1~30	
C16	Low Frame-Shift Speed	15	1~30	
D13	Speed When Over frame	16	0,1,2,...,30	
C72	Emb. Mode	Flat	Flat, Cloth, Cap	
Main Shaft Parameters				
C07	Max. Speed	700-850	250, 300, 350,...,1000	
C09	Minimum Speed	400	250,300,350,...,600	
C08	Shift Stitch Length (mm)	3.0~6.0 (All-servo high speed machine)	1.0~10.0(common type machine), 3.0~6.0 (high-speed machine using Dahao servo-motor driver)	When the stitch length is longer than the set value, the machine will lower the speed.
C10	Jump Stitch Speed	500	400~750(common type machine), 400~1100 (high-speed machine using Dahao servo-motor driver)	Set the rotation speed for jump stitch.
C12	Startup Stitches	1 stitch	1 stitch~9 stitch	Set the startup stitch number before acceleration.
D02	Startup Acce.	12	1,2,3,...,30	Increase the value to bring a quicker speedup after pressing the start key.
C25	Set Break Para.	0	0~30	Range: 0~30. When the main shaft motor is an electromagnetic motor, the value is usually set at 9. When it is a servomotor, the parameter is usually set at 5-7.
D14	Stop Ok bef. Pull Bar	Yes	No, Yes	
C26	Para. Of Needle Down	0	0~30	
Thread-trimming Parameters				
C01	Jump & Trim	3 Jump	No Trim, 1 Jump~7	



Appendix 1 Parameter List

No.	Name of Parameter	Default Value	Range of Value	Remarks
			Jump	
C18	Length of Trim	1	1~8	1 is the minimum length and 8 are the maximum length.
D05	Speed When Trimming	80	80,90,100,...,250	
C20	Lock Stitch. When Trim	Yes	No, Yes	
C11	Slow Stitches After Trim	2 stitch	1 stitch ~7 stitch	
C21	Length of Lock Sti. (mm)	0.6	0.3~1.5	
C19	Lock Num. After Trim	2	0~3	Set the lock stitch number at pulling the bar for embroidery after setting the trimming
C23	Action after Trim	Frame Y	Frame X, Frame Y, Move Needle	
C22	Frame after Trim	No	No, Yes	
D03	Set Hold Startup Para.	0	0~3	
D07	Check Trim is OK	No	No, Yes	
C82	Cut return angle adj	4	0~30	The same as above.
Sequin Parameters (Applicable for JF Sequin)				
C31	Speed for Sequin R	400	300,310, ... ,the maximum speed	
C32	Speed for Sequin L	400	300,310, ... , the maximum speed	
C33	Auto Start for Sequin	No	No, Yes	
D27	Time of Sequin Action	3	0~15	Range: 0-15. For the machine using valve to move the presser, this parameter is generally set at 2~3. For the machine using stepping motor to move the presser, this value is set at 4~5.
C34	Sequin Up after T.B.	No	No, Yes	It is used to control the position of the sequin device after thread-breakage
B17	Up Valve When Jump & No cut	Yes	No, Yes	

Appendix 1 Parameter List



No.	Name of Parameter	Default Value	Range of Value	Remarks
D54	Motor Number of R Sequin		No,1~4,1(2~4)	Set the parameter base on sequin device. 2~4 mean device number driven by one motor
D55	Set 3MM of R Sequin		One-way 6~40 steps; Double-ways 6~40 steps	
D56	Set 4MM of R Sequin		One-way 6~40 steps; Double-ways 6~40 steps	
D57	Set 5MM of R Sequin		One-way 6~40 steps; Double-ways 6~40 steps	
D58	Set 6.75MM of R Sequin		One-way 6~40 steps; Double-ways 6~40 steps	
D59	Set 9MM of R Sequin		One-way 6~40 steps; Double-ways 6~40 steps	
C57	A Size&Color of R Sequin	5mm yellow	3/4/5/6.75/9mm Yellow /Purple/Blue /Green/Red/Golden/ Silver/Black	
C58	B Size&Color of R Sequin	5mm blue	3/4/5/6.75/9mm Yellow/Purple/Blue /Green/Red/Golden/ Silver/Black	
C59	C Size&Color of R Sequin	5mm silver	3/4/5/6.75/9mm Yellow /Purple/Blue /Green/Red/Golden/ Silver/Black	
C60	D Size&Color of R Sequin	5mm golden	3/4/5/6.75/9mm Yellow /Purple/Blue /Green/Red/Golden/ Silver/Black	
D60	Sequin Gap Num of R Sequin	No	No, 1,2	
C65	Valve Time of Right Sequin	0	0~5	
D61	Motor Number of L Sequin		No,1~4,1(2~4)	Set the parameter base on sequin device. 2~4 mean device number driven by one



Appendix 1 Parameter List

No.	Name of Parameter	Default Value	Range of Value	Remarks
				motor
D62	Set 3MM of L Sequin		One-way 6~40 steps; Double-ways 6~40 steps	
D63	Set 4MM of L Sequin		One-way 6~40 steps; Double-ways 6~40 steps	
D64	Set 5MM of L Sequin		One-way 6~40 steps; Double-ways 6~40 steps	
D65	Set 6.75MM of L Sequin		One-way 6~40 steps; Double-ways 6~40 steps	
D66	Set 9MM of L Sequin		One-way 6~40 steps; Double-ways 6~40 steps	
C61	A Size&Color of L Sequin	5mm yellow	3/4/5/6.75/9mm Yellow /Purple/Blue /Green/Red/Golden/ Silver/Black	
C62	B Size&Color of L Sequin	5mm blue	3/4/5/6.75/9mm Yellow/Purple/Blue /Green/Red/Golden/ Silver/Black	
C63	C Size&Color of L Sequin	5mm silver	3/4/5/6.75/9mm Yellow /Purple/Blue /Green/Red/Golden/ Silver/Black	
C64	D Size&Color of L Sequin	5mm golden	3/4/5/6.75/9mm Yellow /Purple/Blue /Green/Red/Golden/ Silver/Black	
D67	Sequin Gap Num of L Sequin	No	No, 1,2	
C66	Valve Time of Left Sequin	0	0~5	
Taping Parameter				
D86	A-Zig Emb.Right On/Off	Yes	Yes(First Stitch), No	
D87	A-Zig Emb.Left On/Off	Yes	Yes(Last Stitch), No	

Appendix 1 Parameter List



No.	Name of Parameter	Default Value	Range of Value	Remarks
D88	A-Zig Emb. On/Off Time	2		
D90	A-Zig Swing Angle	90	0~90	Generally, please set it above 80
D91	A-Zig Max Speed	850	300~1000	
D92	A-Zig Has Loosing-Motor	Yes	Yes, No	
D93	A-Zig T.L Adj	5	0~10	
D94	A-Zig 5 Swing Angle	0.2	-10.0~10.0	
D95	A-TAPING Emb.righe origin pos.	0	0~100	
D96	A-TAPING Emb.left origin pos.	0	0~100	
D97	A-TAPING Up&Down Detect.	No	No, Yes	
Machine Parameters				
D01	Needles	6	1,2,...,MAXNEEDLE	Set the value according to the machine situation. E.g. the value should be 9 for 9-needle machine. If the value is different from the machine needles, the color changing will be abnormal.
D43	CloseBack Light time	15 mins	Never, 2mins, 5mins, 10mins, 15mins	
C40	No Output Design	No	No, Yes	
C71	Thread hold voltage adj.	6	1~10	
C41	Server Port	1600	1~65535	It is used for setting sever port when it is connected to PC.
C42	MAC Address	00112233445 5	001111111111~00999 9999999	It is used for setting the MAC address of embroidery machine network card. The address is different at different machine.
C43	IP Address			It is used for setting machine address when connected to PC. It is not different among different machines.



Appendix 1 Parameter List

No.	Name of Parameter	Default Value	Range of Value	Remarks
C44	Server IP			It is used for setting the IP address of sever when connected to PC.
C45	Subnet mask			It is used for setting the subnet mask of IP address when connected to PC.
C46	Gateway			It is used for setting the gateway of machine when connected to PC.
E1	DIP1	3	0~255	
E2	DIP2	3	0~255	
E3	DIP3	3	0~255	
E4	DIP4	3	0~255	



Appendix 2 Directions of U Disk Operation

No	Operations	Methods or Standards	Remarks
1	USB I/O	Same as floppy disk	
2	Operation priority between USB disk and floppy disk	USB Disk	
3	Format supported by USB disk	FAT16 and FAT32	
4	Support long file name	Support, but not displayed	
5	File name format	DOS 8.3 mode (8 digit prefix is viewable, suffix is 3 digits)	For instance: “清明上河图.DST” will be displayed as “清明上~1.DST”
6	Support file name in Chinese	Support	
7	Sub-directory operation	Support	
8	Sub-directory limitation	No. It could be countless in theory	
9	File number in one sub-directory	400	
10	Reading & writing error/ change USB	Back to disk management or design management interface, insert the disk again.	
11	Multi-logical disks in one USB	Support	
12	Formatting USB	Support	
13	Installation of the letter base	Not Support	
14	Software update	Support	
15	Special character in file name	Support, except “\$”.	



Appendix 3 Error List

Note: for the errors listed below, you may click “Clear” to check related parts. Follow the instructions at below. If the machine has no password-protected function, please omit the items relating to password at below:

Error Number	Error	Solutions
Upper Machine Error		
01	Operation Failure	
02	Operation Stop	
03	Communication Error to Down Machine	Repower the machine
06	Not set ZERO point	Perform the “Set Frame Origin/ Power-off Protection”
07	Fail to set ZERO point	Reset it.
08	No design start point	Perform “Save Design Start Point”
09	No software range	Perform “Set Frame Soft Protection”
10	Password is wrong!	Input the right passwords
11	New passwords not same	Re-input
12	Emb. design not existed!	Design has been deleted
13	Dest. design existed!	Re-perform the operation or perform the operation after repower or perform the operation after the “Clear All Memory Design”
14	Design not existed!	
15	Open design error!	
16	Error type combined design	
17	Open FLASH media error	
18	Design has created!	
19	No enough design mem.	Delete some designs
20	Directory is invalid.	Re-perform the operation or perform the operation after repower or perform the operation after the “Clear All Memory Design”
21	FLASH media write-protect	
22	Design file not existed	
23	Design name is invalid	
24	Design file corrupt	
25	Error read/write design	
26	Not open design file	Re-perform the operation or perform the operation after the “Clear All Memory Design”
27	FLASH media I/O Error	
28	Device not existed!	Re-plug or repower machine



Error Number	Error	Solutions
29	No floppy disk	
30	Invalid disk type	
31	Disk sector error	
32	File not in disk	
33	Not a file	
34	File corrupt	
35	Disk write protect	Turn off write protect switch
36	Invalid directory	Select the right path
37	File existed!	Rename it
38	Directory is full in memory.	Delete some designs
39	Not enough space	Delete some designs
40	Media not open	Re-perform the operation or perform the operation after repower or perform the operation after the “Clear All Memory Design”
41	Error design data	
42	Invalid design type	
43	Not normal design	
44	Not combined design	
45	Please wait design operation	Re-perform the operation or perform the operation after repower or perform the operation after the “Clear All Memory Design”
46	Cannot delete emb. design	
47	Stitch number too large	
48	Design stitches is over	
49	Error design, or communication fail	
51	Design Read Error	
52	Edit Forbid when Emb. Ready	Release the embroidery confirmation
53	Design is too big. Can't process.	
54	Can not format the disk!	
55	Unsupported operation!	
56	Disk Error	
Down Machine Error		
EC05	The hook is not ok	
EC07	Hooking time is out	
EC08	Not set (e. Set)	Confirm design for embroidery
EC09	Cannot return	
EC10	Cannot return	
EC11	Design not exist	Reselect design
EC12	Stop position err	Turn the main shaft wheel



Appendix 3 Error List

Error Number	Error	Solutions
		to 100 degree. Then adjust “Set Break Para.”
EC13	Frame over limit	Because the parameters “Set Frame Soft Protection” has been set and it is over the set range at moving the frame, user can release this parameter according to the situation.
EC14	Control memory lost	
EC16	Step motor err	1. Check whether the frame is blocked; 2. Make sure the frame motor is ok. 3. Exam whether frame driver is damaged.
EC17	Change clr overtime	1. Check whether the color-changing motor is rotating. 2. if it can rotate, please check the color-changing rheostat, and the connection between that rheostat and color-changing motor
EC18	Half return err	1. Use color-changing wheel to correct the needle position. 2、Check whether the color-changing rheostat is damaged or the connection between the rheostat and the color-changing motor is off.
EC19	Needle position err	1. Use color-changing wheel to correct the needle position. 2、Check whether the color-changing rheostat is damaged or the connection between the rheostat and the color-changing motor is off.
EC20	Main motor overtime	1. Check whether the motor can rotate. 2. If it can rotate, please check whether the coupler on the E923A board is blocked by oil. 3. Check the



Error Number	Error	Solutions
		connection between E918X and the encoder plug of main shaft motor. 4. Check whether the driver of E918 is broken.
EC21	Change clr overlimit	Check whether the color-changing rheostat is damaged, and the whether the setting of “Needles” is right.
EC22	Main motor reverse	Check the 14P plug on the main shaft motor encoder is loose or the rheostat is damaged
EC23	Cannot embroider	
EC24	Cannot frame back	
EC26	Can not trim	Check whether it is due to mechanical reasons or knife return detection sensor is broken
EC36	Sequin is on	Dial the sequin switch to lift the device and then perform this operation again.
EC37	Pull bar error	
EC38	Spe. Emb. Overtime	
EC41	File not exist	Re-perform the operation or perform the operation after repower or perform “Clear All Memory Design”
EC42	File directory full	Delete some designs
EC43	Memory space full	Delete some designs
EC44	File fat err	Re-perform the operation or perform the operation after repower or perform “Clear All Memory Design”
EC45	File directory err	Re-perform the operation or perform the operation after repower or perform “Clear All Memory Design”
EC46	Bad disk sectors	Replace disk
EC95	Thread is broken, press key	
EC101	Transfer crc error	Repower the machine



Appendix 4 Method for Making Special Multi-sequin Design

1、 Principle of Dahao special multi-sequin design

The normal design making system identify a sequin code as a jump stitch, but it can not distinguish several sequin combinations at one stitch position. For instance, it can not recognize it's a sequin A or B at one stitch position. Dahao special multi-sequin design making is to add a few jump stitch codes after the original sequin code (jump stitch or stitch length is less than 0.1mm) to indicate sequin combination, thus realizes the embroidery of overlap sequin on one stitch position. For instance, "A+C" means overlap sequin of A and C.

The followings are the specific rules:

The value of sequin A is 1, we use 1 sequin code to represent it.

The value of sequin B is 2, we use 1 sequin code and 1 jump stitch to represent it.

The value of sequin A+B is 3, we use 1 sequin code and 2 jump stitches to represent it.

The value of sequin C is 4, we use 1 sequin code plus 3 jump stitches to represent it.

The value of sequin A+C is 5, we use 1 sequin code plus 4 jump stitches to represent it.

The value of sequin B+C is 6, we use 1 sequin code plus 5 jump stitches to represent it.

The value of sequin A+B+C is 7, we use 1 sequin code plus 6 jump stitches to represent it.

The value of sequin D is 8, we use 1 sequin code plus 7 jump stitches to represent it.

The value of sequin A+D is 9, we use 1 sequin code plus 8 jump stitches to represent it.

The value of sequin B+D is 10, we use 1 sequin code plus 9 jump stitches to represent it.

The value of sequin A+B+D is 11, we use 1 sequin code plus 10 jump stitches to represent it.

The value of sequin C+D is 12, we use 1 sequin code plus 11 jump stitches to represent it.

The value of sequin A+C+D is 13, we use 1 sequin code plus 12 jump stitches to represent it.

The value of sequin B+C+D is 14, we use 1 sequin code plus 13 jump stitches to represent it.

The value of sequin A+B+C+D is 15, we use 1 sequin code plus 14 jump stitches to represent it.

2、 Making Motif for Multi-sequin

By using the function of making motif, we can easily input sequin or sequin combinations, including: A, B, A+B, C, A+C, B+C, A+B+C, D, A+D, B+D, A+B+D, C+D, A+C+D, B+C+D, A+B+C+D, etc.

Here, we will take the design of sequin B as an example.

- 1) Open any design making software. First we zoom in the blank to certain scale (For easy inputting several sequins in a place) and go into “Sequin Status”.
- 2) Input a sequin.

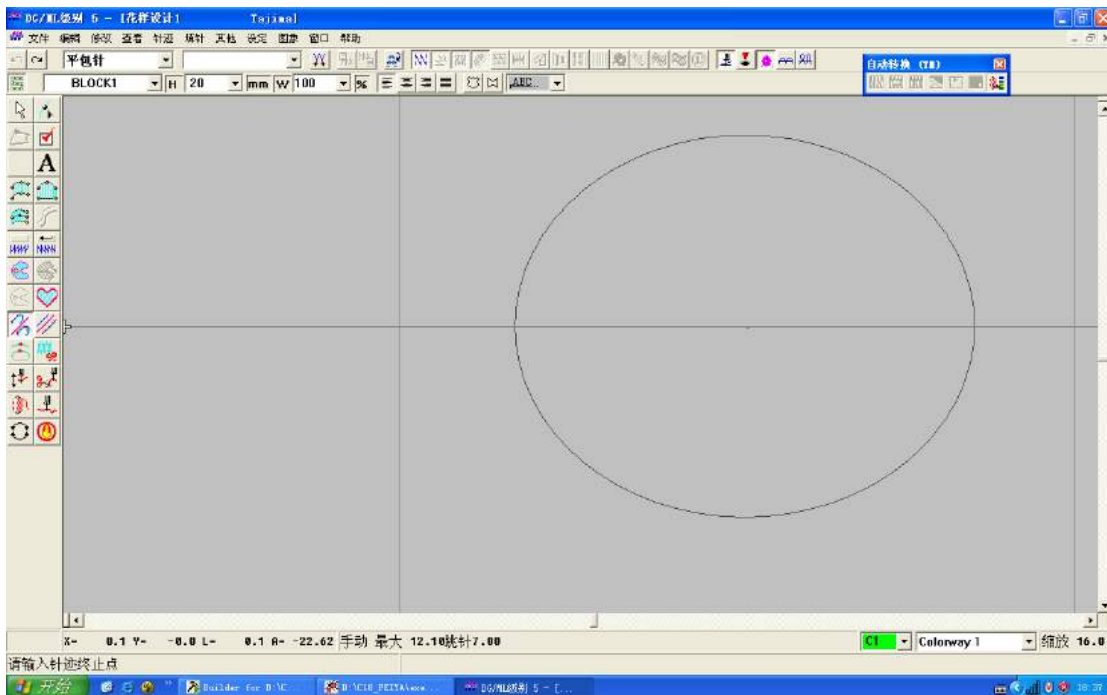



- 3) Since the value of sequin B is 2, we should put 2 sequins in here, which means, we have to add another sequin on the basis of the above procedure, as shown in below:.

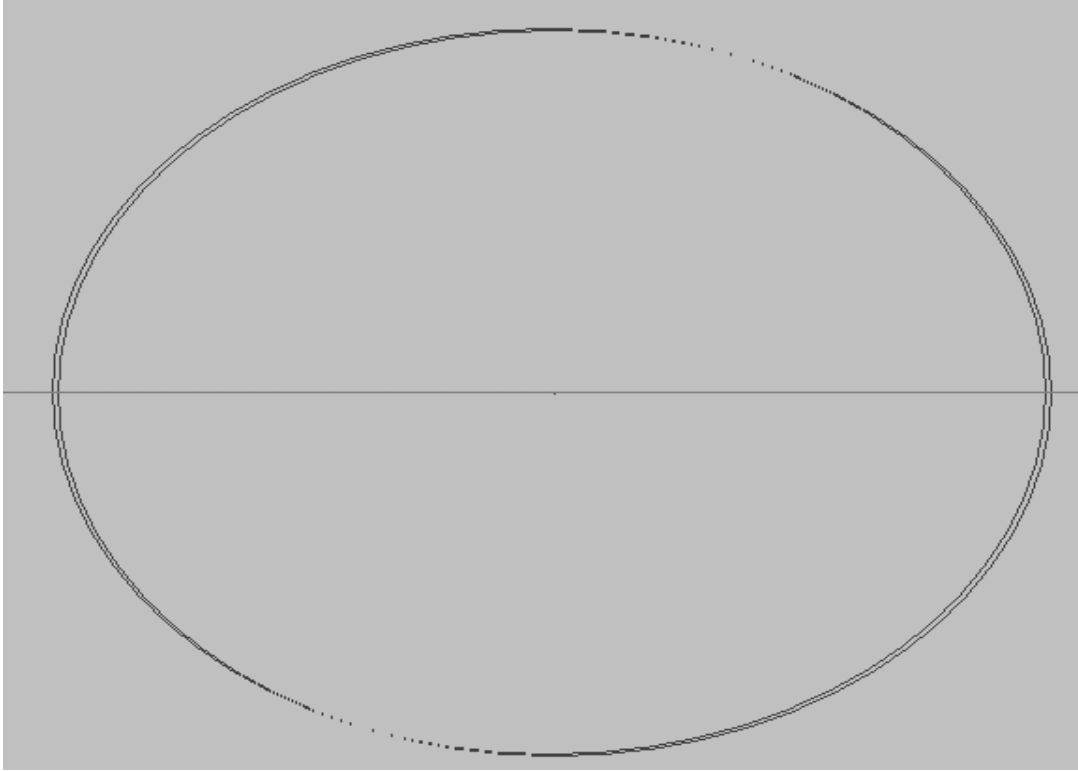

- 4) Continue to input other single-stitches, as shown at below:

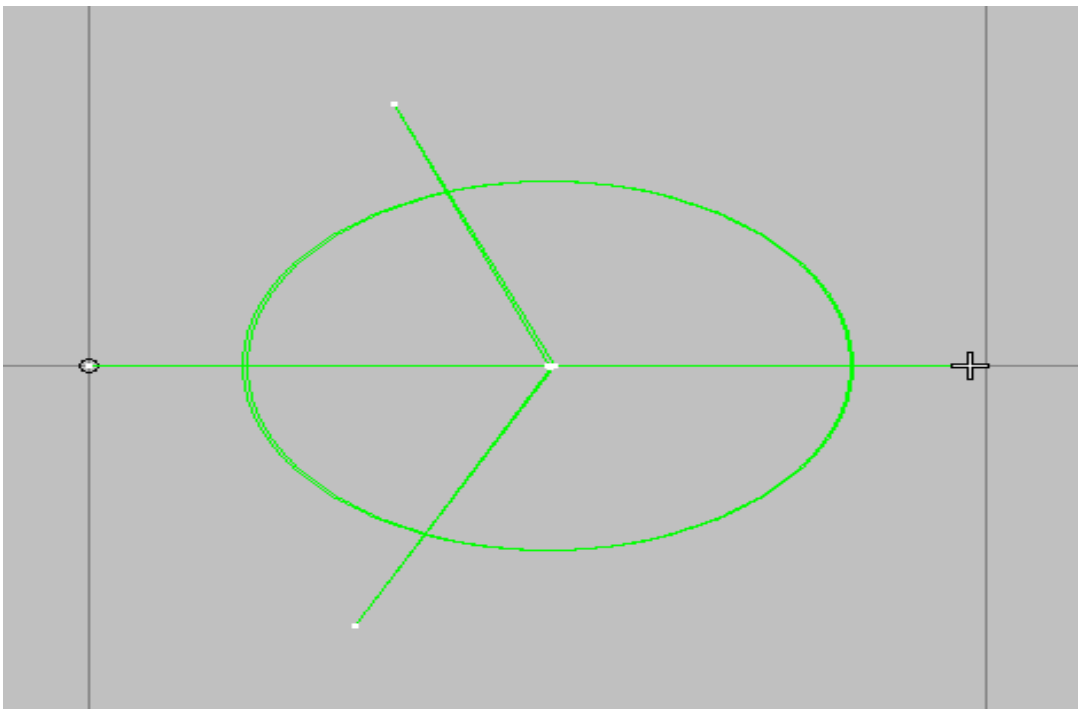



5) You can see “stitch list” shows 2 sequins as in the following image.

6) Select all stitches.

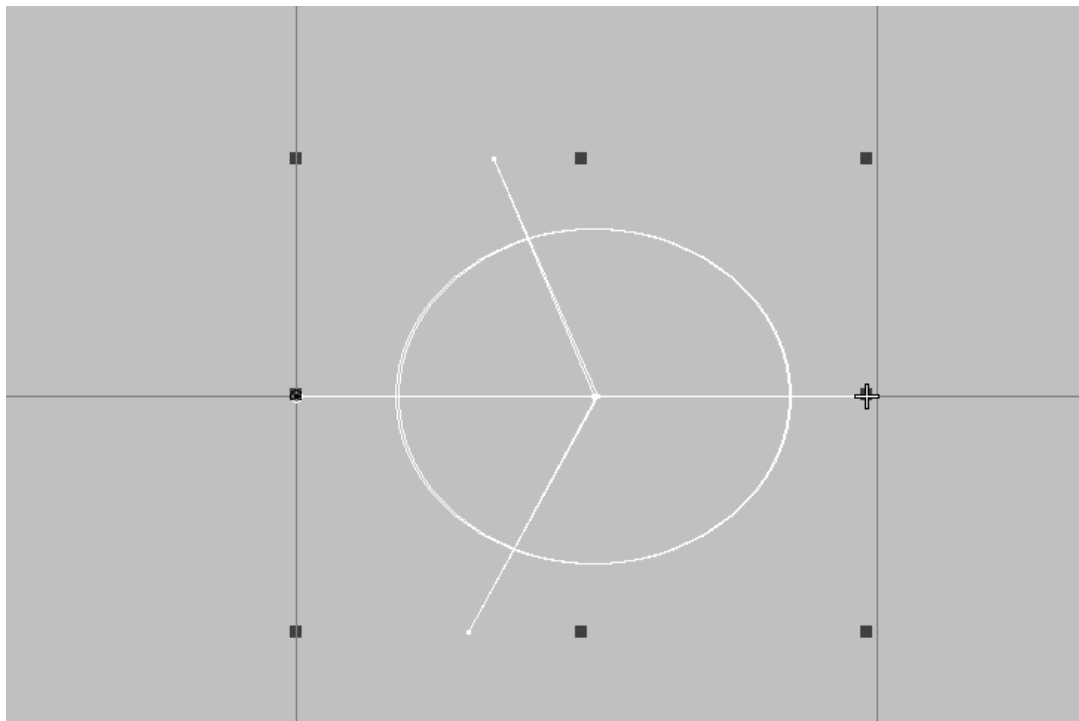

7) Make the motif. Set the group as JP, name as JP-B

8) Input two reference points.

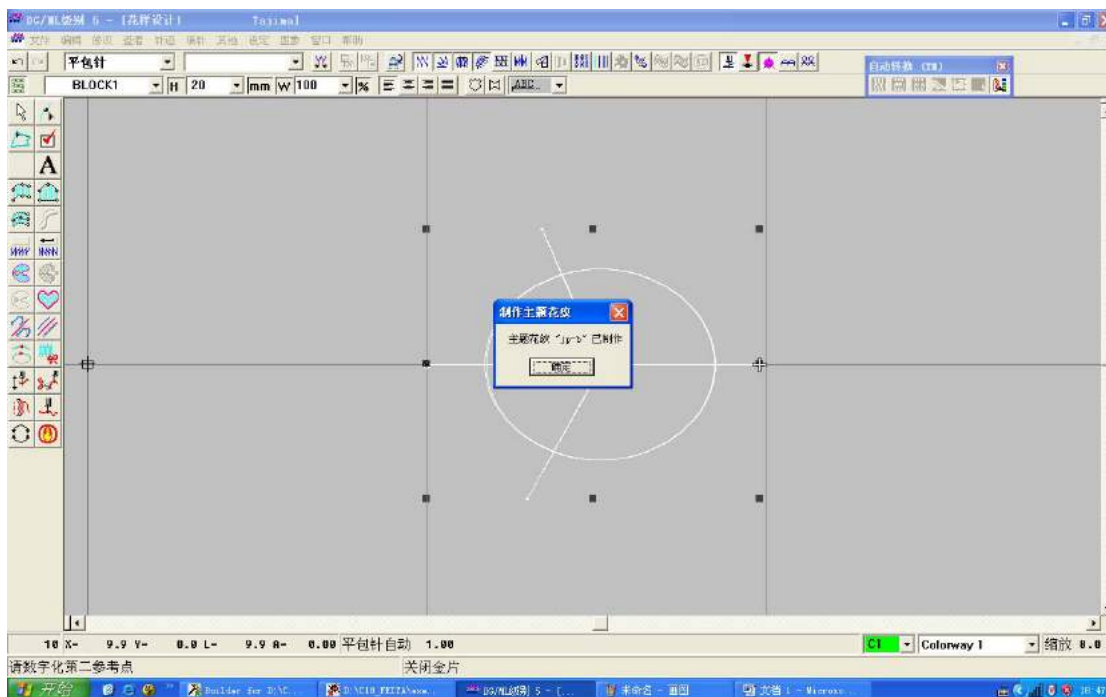

3、 For using single needle to make multi-sequin design, you can use “stitch form ->



motif -> apply”. Then use “manual stitch” to finish entering, as shown in below:

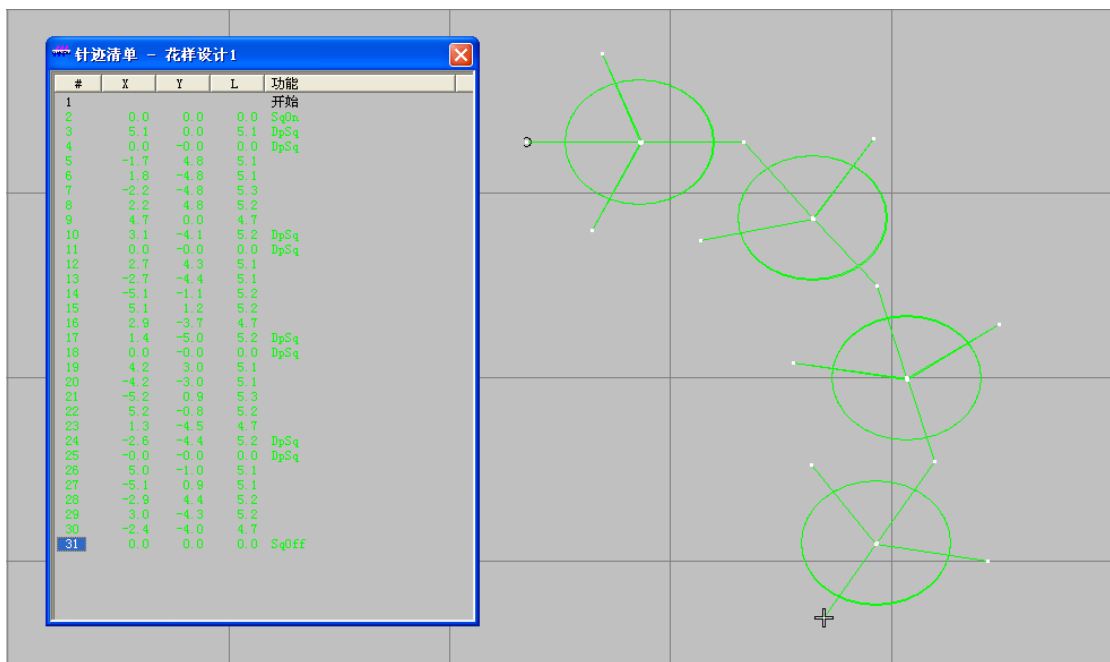
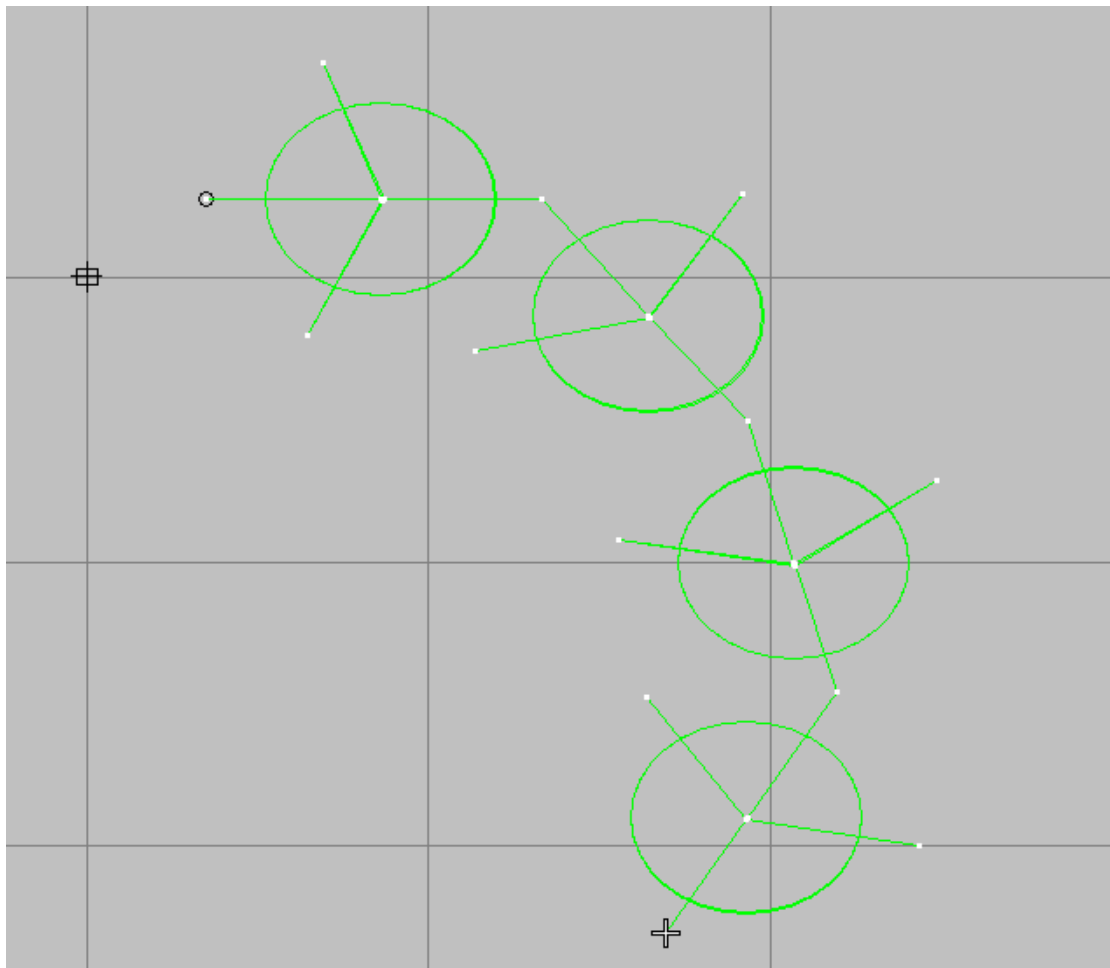

4、 At making multi-sequin, others (curve) can apply motif too.



- 1) Click sequin button to enter “sequin state” (this is to ensure all the curve is covered by sequin). Input the curve as the following picture.

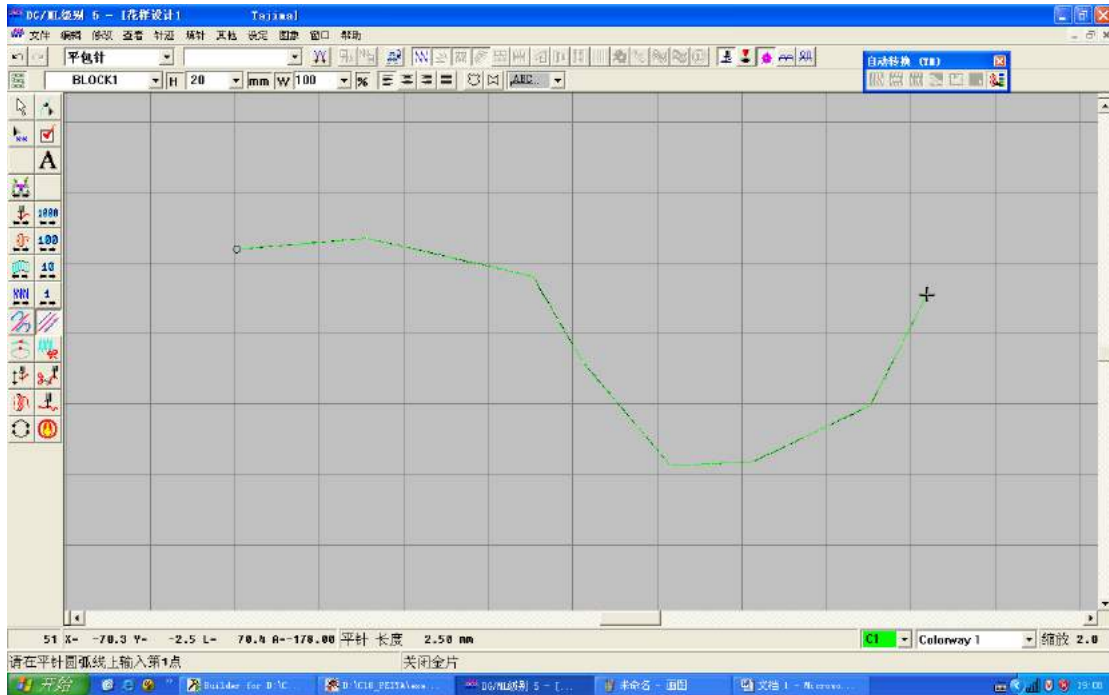

- 2) Select the target.

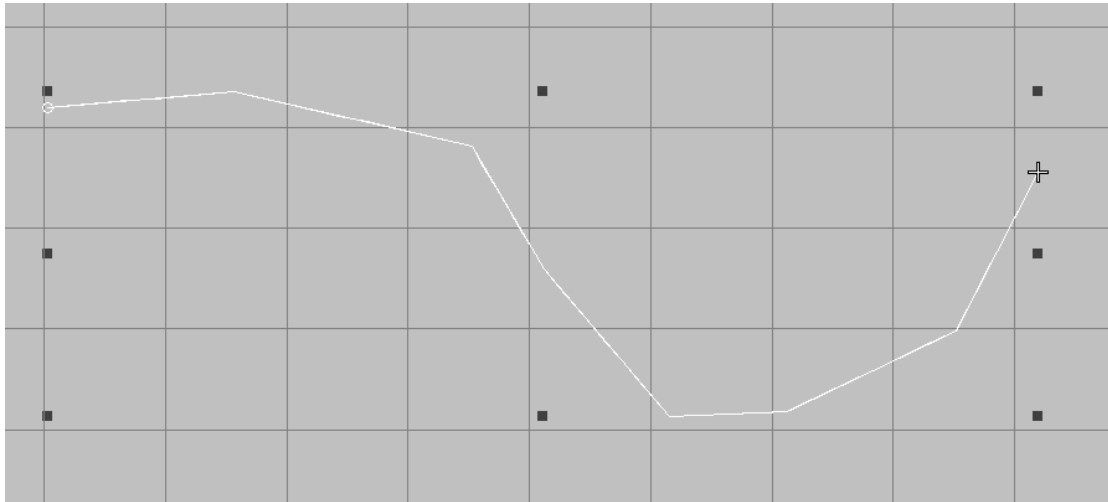

- 3) Set the “target properties” and select the corresponding motif.

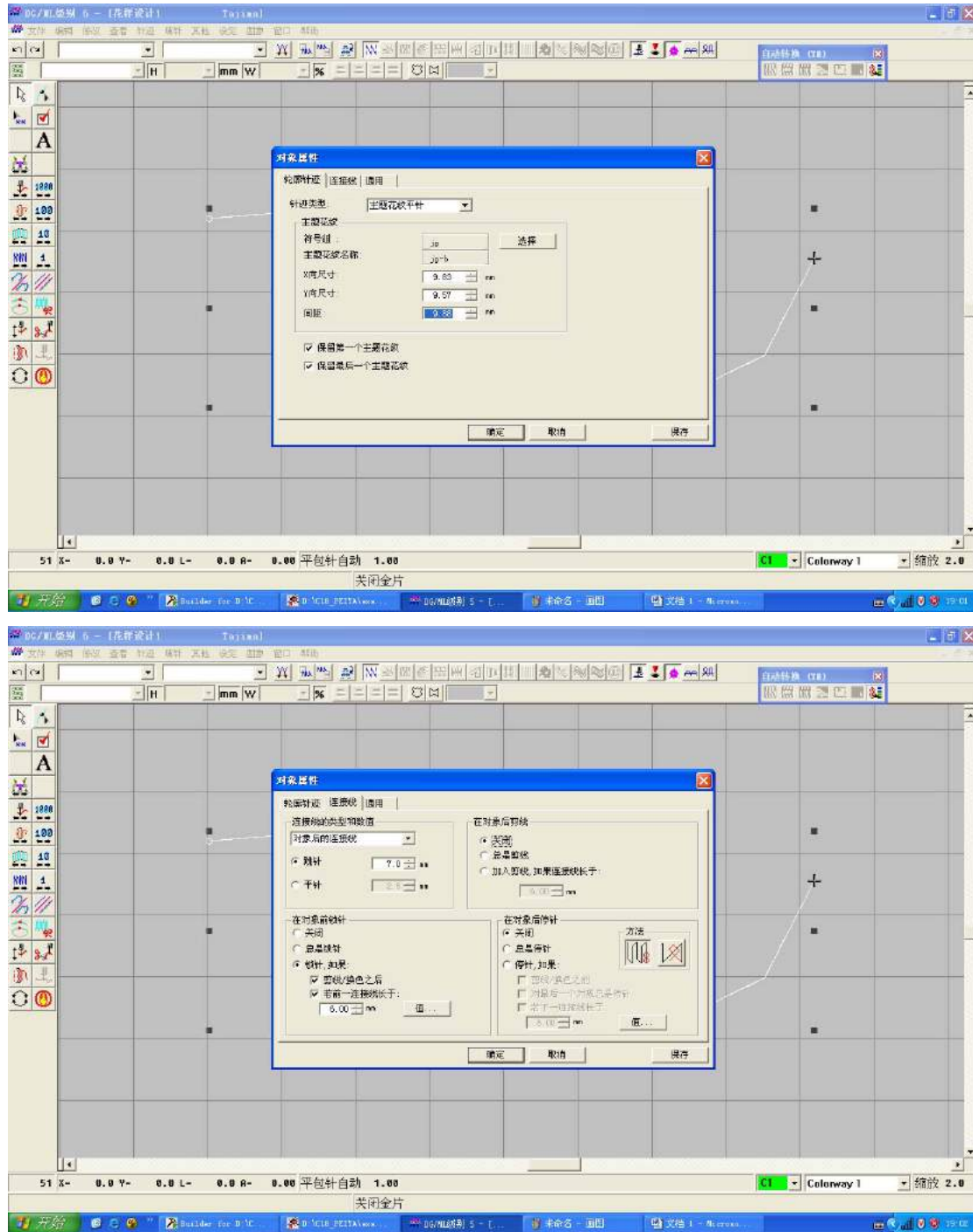

4) “Multi-sequin” input is finished.

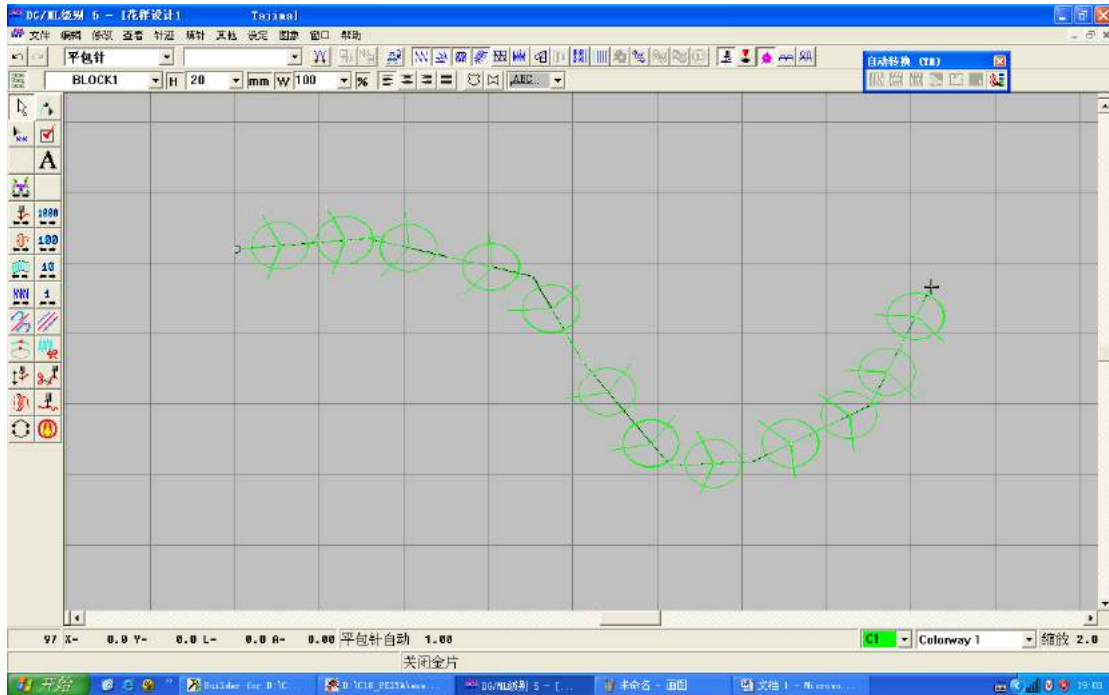

5、 Make Alternate Sequin

This is to realize the alternative embroidery of different sequins. For instance, A1B1 embroidery is to realize the embroidery effect of A, B, A, B...

- 1) Firstly, you should design the alternating motif, as the following A1B1 alternating design:

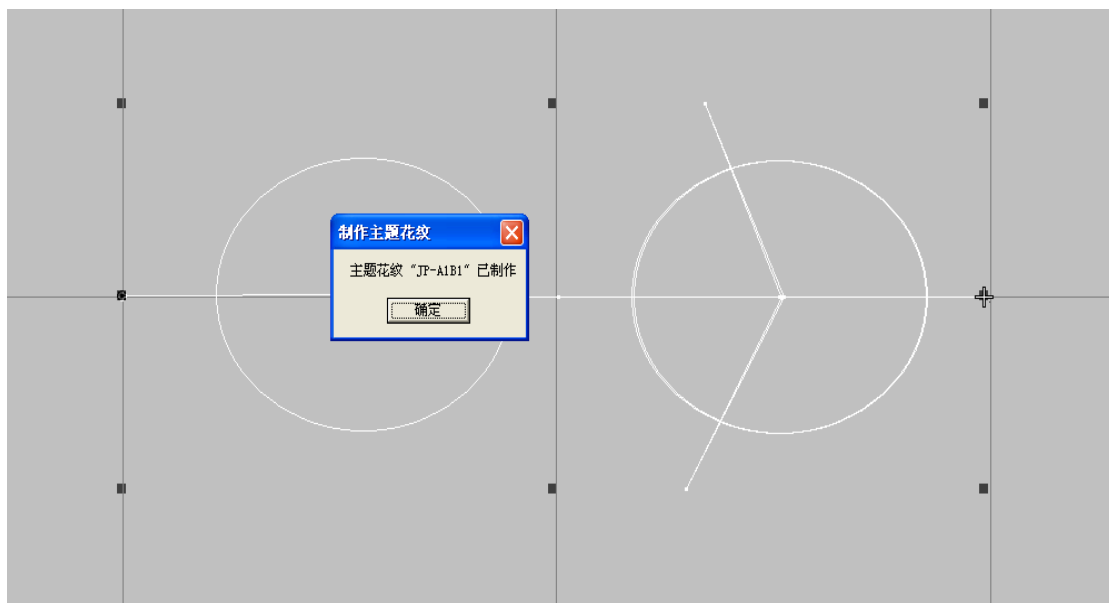

- 2) Apply the above motif in the design to achieve the alternating of A1B1 sequin, as shown in below:

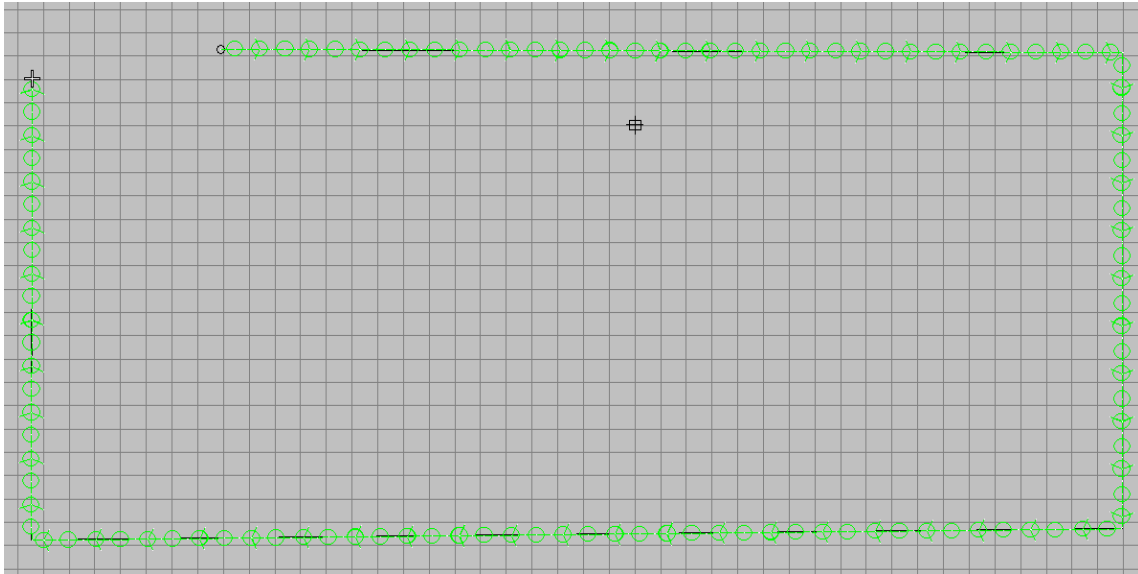

6、 Design maker should build up design data base (motif base)

Now we have sequins: 3MM, 4MM, 5MM, 6.75MM and 9MM. while the first needle position can have 4 sequin delivery devices at most. So we can get the following 15 combinations: A,B,AB,C,AC,BC,ABC,D,AD,BD, , ABD,CD,ACD,BCD and ABCD.

The motif base should be the combination of the above sequins and sequin groups.

If there are two sequin-feeding devices A and B: One design uses 3MM sequin and 5MM sequin. Then the motif base of it should contain 3MM-A, 5MM-B, and 5MM-AB. While the other design uses 4MM sequin and 6.75MM sequin, then the motif base should contain 4MM-A, 6.75MM-B and 6.75MM-AB.

If there are three sequin-feeding devices A, B and C: one design document uses 3MM, 4MM and 6.75MM sequin, then the motif base should contain 3MM-A, 4MM-B, 4MM-AB, 6.75MM-C, 6.75MM-AC, 6.75MM-BC and 6.75MM-ABC. While the other design uses 3MM, 6.75MM and 9MM sequin. Then the design data base should contain 3MM-A, 6.75MM-B, 6.75MM-AB, 9-C, 9-AC, 9-BC and 9-ABC.

The motif data bases of other machines are in the same principles.

The alternating sequin motif data base should combine single sequin and overlap sequins. For instance, 3MM-A sequin base and 4MM-AB sequin base can form the alternating sequin of 3MM-A & 4MM-AB, which achieves embroidery effect of A, AB, A, AB...

7、 Normal sequin design to Dahao special sequin design

According to the above rules, we just need to insert some jump stitches after “sequin code” to change the original sequin code to “multi-sequin code”.



- 1) If you want to change the first sequin code to A+B sequin code, you need to locate to that stitch first (Its character is to put down the sequin).
- 2) Right click “insert jump stitch” twice to insert two jump stitches after the original sequin code.

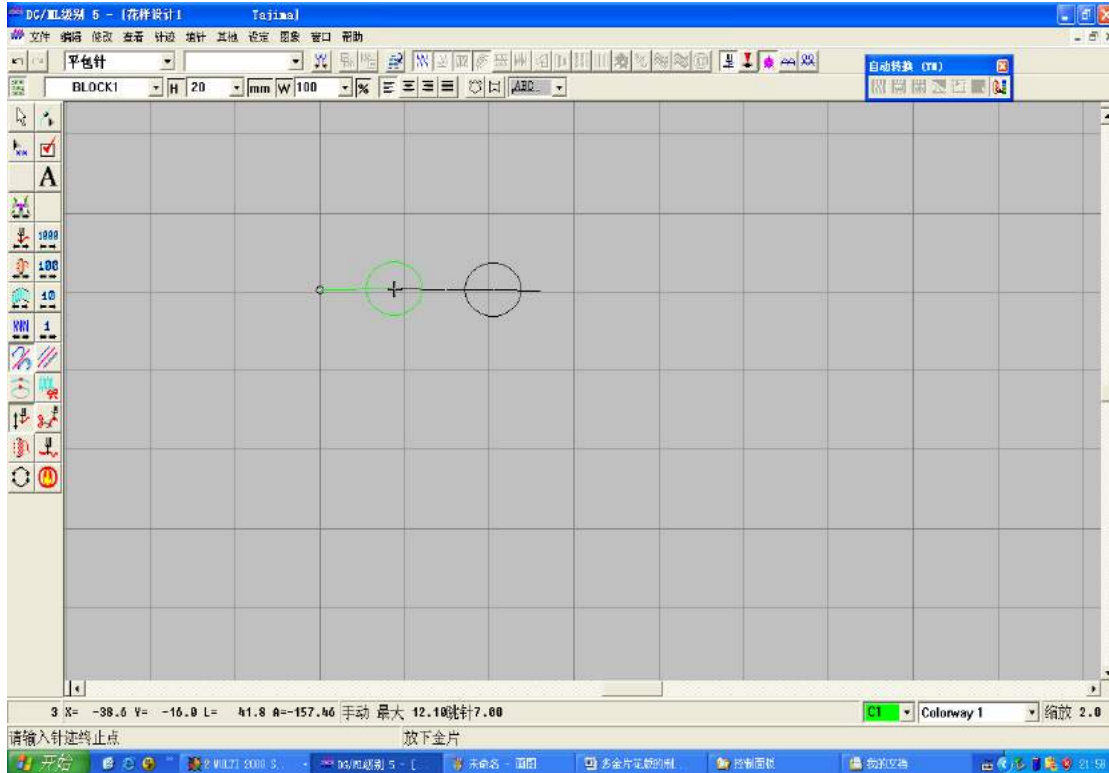

- 3) You can see the stitch list as the following image. The effect of embroidery: The first sequin is overlap A+B, the second one is sequin A.

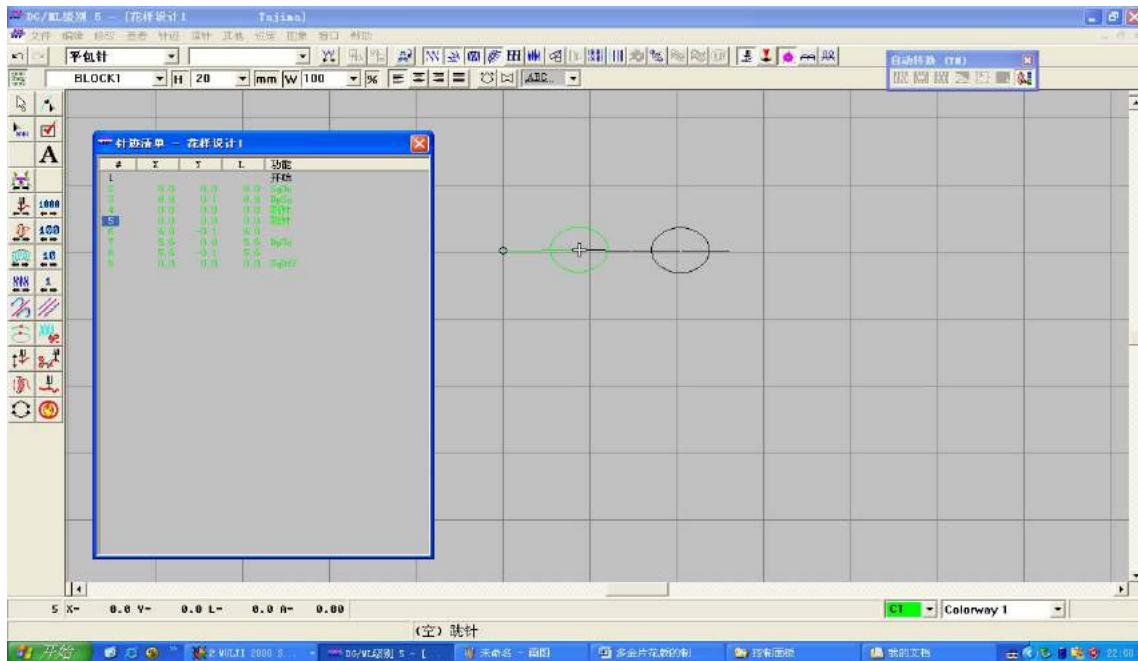

Save as the TAJIMA DST document.



Appendix 5 Network Function of Embroidery Machine

1 How to Make Ethernet Cable

1.1 Method of Making Straight-through Cable

The pins in the two terminals of twisted-pair cable have to be in one-to-one correspondence. If the first pin of one terminal is green, the first pin of the other terminal must also be green. The twisted-pair cable made in this way is usually called “straight-through cable”.

Connections:

Pin Number	1	2	3	4
Pin Color	Orange & white	Orange	Green & white	Blue
Pin Number	5	6	7	8
Pin Color	Blue & white	Green	Brown & white	Brown

Shown in the following picture::

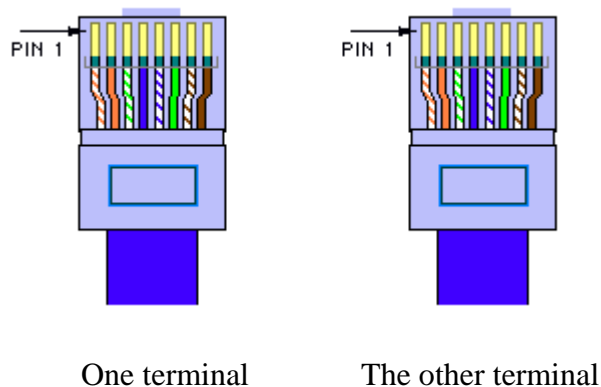

Usage: a. Link switch or HUB to router;

b. Link computer (including server and workstation) to switch or HUB

1.2 Method of Making Crossover Cable

1—3, 2—6 crossover connection: Twisted-pair cable has 4 pairs of pins (8 pins). Only 4 pins are used in network, namely the first, second and third, sixth pins. They are used for receiving and sending signals. The connection rule is: the first pin of one terminal is connected to the third pin of the other terminal, and the second to the sixth. Other pins are



connected to the corresponding pins. Cable made in this way is called “crossover cable”.

Pin Number	1	2	3	4
Corresponding Pin Number	3	6	1	4
Pin Color	Green & white	Green	Orange & white	Blue
Pin Number	5	6	7	8
Corresponding Pin Number	5	2	7	8
Pin Color	Blue & white	Orange	Brown & white	Brown

Shown in the following picture:

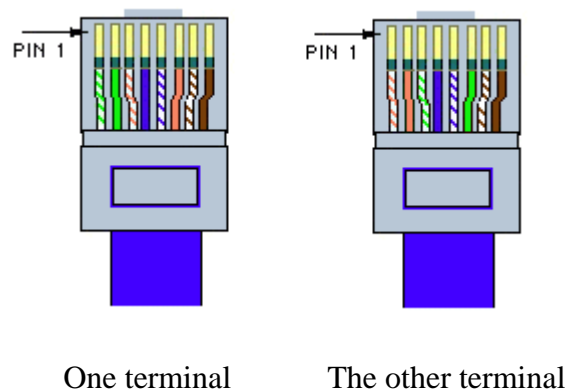

Usage:

- a. Connection between switches through UPLINKS interface
- b. Connection between HUB and switch
- c. Connection between HUB and HUB
- d. Direct connection between 2 PCs (NIC to NIC)
- e. Connection between interfaces of Routers
- f. Connection between ADSL Modem (Ethernet interface) and NIC of PC

2 Notes for network setting parameters

2.1 MAC address

In physical transmission of network bottom level, the computers are recognized by physical address (MAC). So it's necessary to keep the uniqueness of MAC address. When the first two digits of MAC address are not zero, some network equipments regards it as illegal MAC address, thus the equipment can't be linked to the network. So the first two



digits of MAC address must be zero.

2.2 IP address

1) Definition of IP address

IP also called Internet address, which is the logic address for solely marking the computers in internet. Every computer in the internet relies on the IP address to mark itself. It's like we find the phone by the phone number in the phone book. In one network the IP address must be unique.

2) Form of IP address

One IP address includes 4 decimal integers portioned by decimal points. Each integer is in fact composed of 8 binary numbers. So the maximum of each integer is 255 and the minimum is 0.

3) Structure and classification of IP

The four numbers of IP address can be divided into 2 parts. One is network number for marking the network. Another is computer number for marking the specific machine in one network. IP addresses are divided into 3 kinds: A, B and C.

A: the first number represents network and the following 3 numbers represent computer.

B: the first two numbers represent network and the following 2 numbers represent computer.

C: the first three numbers represent network and the last one represents computer.

We will use the following example to explain the network number and computer number of C type.

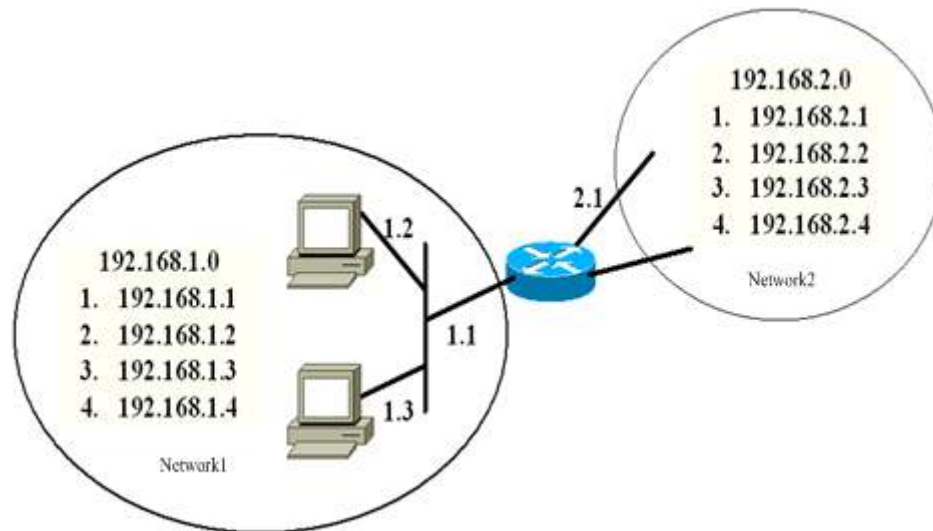

Network	Network Number	Computer Number
1	192.168.1	.1
1	192.168.1	.2
1	192.168.1	.3
1	192.168.1	.4
2	192.168.2	.1
2	192.168.2	.2
2	192.168.2	.3
2	192.168.2	.4

2.3 Subnet mask

To show how the network number and computer number are divided, subnet mask is used to tell in one IP address which part is for network and which part is for computer. It's regulated that "1" is for network part and "0" is for computer part. IP address and subnet mask combine to tell in which network the computer is. So the subnet mask is very important. If it's wrong, it will get the wrong network address. Therefore the same network number must be set with the same subnet mask.

2.4 Gateway

It's the IP address of the router which is in the same subnet of the computer. As in the followed picture, if one data package needs transmitting to a computer in network 2, this data package has to be sent to the router linked to us. It's like in sending by post, you only need to deliver a letter to postman instead of delivering by yourself. So when the computers are not in the same network segment, the gateway also has to be set properly in setting computers.



Otherwise computers don't know where to deliver the data package.

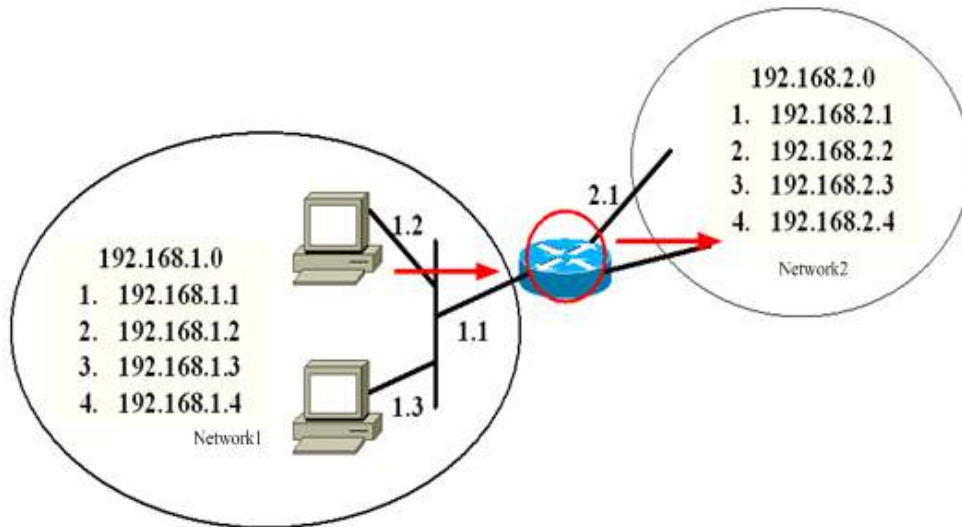

3 The ways to construct network

3.1 One PC directly connected to one embroidery machine

In this situation crossover cable is used to link the network interface of PC and the network interface of embroidery machine.

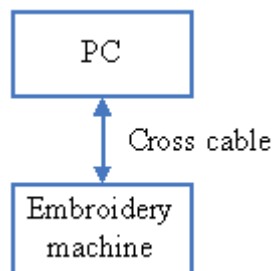

3.2 PC and embroidery machine linked by HUB

In this situation straight-through cable is used to link PC or embroidery machine with HUB.

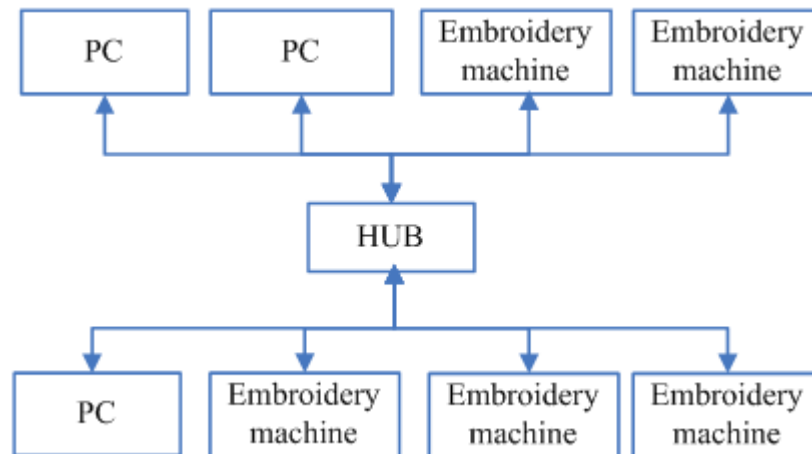

3.3 Connect the two networks in “2” through router

4 Setting the network parameters of embroidery machine

4.1 MAC address of embroidery machine

Set MAC address of NIC of embroidery machine. Each embroidery machine has its sole address. The range of this parameter is 000000000000~00FFFFFFFF.

4.2 IP address of server

This parameter has to be the IP address of the PC installed with EmbNetServer. This address can be found in the display window of EmbNetServer.

For the installation and usage of the EmbNetServer, please refer to the disk attached

4.3 Server port No.

This parameter value is the port number used by EmbNetServer. The number can be found in the display window of EmbNetServer.

4.4 IP address of embroidery machine

Set the IP address of embroidery machine when it's linked with PC. The IP addresses of embroidery machines can't be repeated. In one sub network, the network numbers of embroidery machines and PCs have to be the same. And their computer numbers have to be different.

4.5 Subnet mask

Set the subnet mask of IP address of embroidery machine when it's linked with PC. In one sub network, the subnet masks of embroidery machines and PC's have to be the same.

4.6 Gateway address

If embroidery machines are in the two different sub networks, the gateway address has to be set. Otherwise there's no need to set it.



Appendix 6 Automatic Limits Function for Cloth Embroidery/ Cap Embroidery

1. Working Principles

The automatic limits function is to use the X-/Y+ limits coupler as the origins. The system will determine the embroidery range of that frame according to the frame size and the distance between the origin and the set frame center (Unit: mm). Once the embroidery is over this range, the controller will activate the automatic protection to prevent the mechanical device from being damaged. There are 10 different default frames preset in the 185 controller, including 9 cloth embroidery frames and 1 cap embroidery frame.

2. Method for Setting the Automatic Limits of Cloth Embroidery

(1) Set Frame Origin

Use “Auto Frame Origin” to set the frame origin. The specific method is at below:

Turn the menu to the last page and click



to enter the “Other Function” menu





Select “Power-off Frame Protection/ Frame Origin” to enter the interface for setting the frame origin:

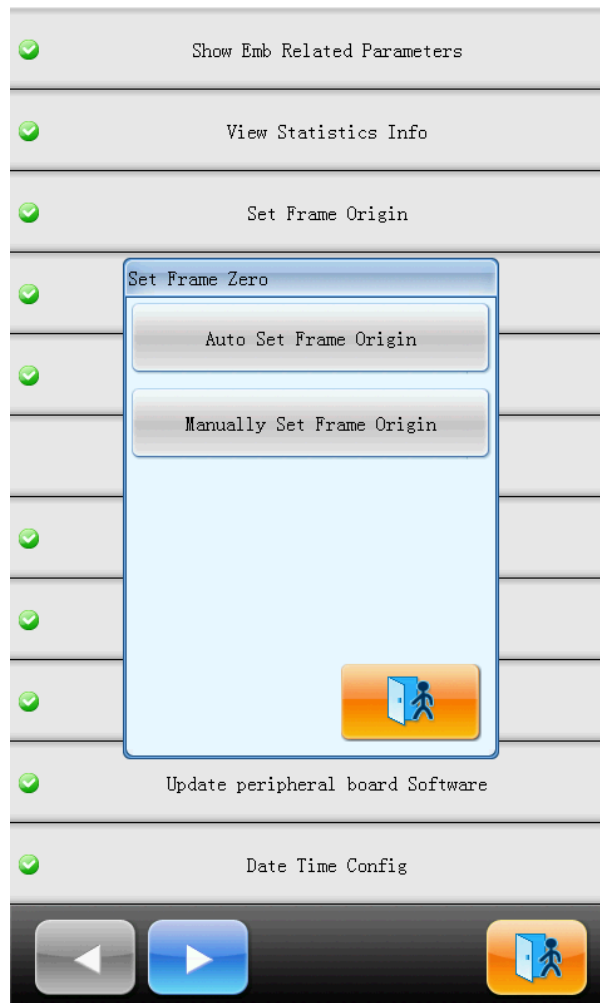

Select “Auto Frame Origin” and then click “Confirm”. At this moment, the frame will automatically find the origin and confirm it. (**Note:** when the limits coupler is damaged, user can use “Manual Frame Origin” to confirm the frame origin.)

(2) Settings of Frame Center and Frame Size

In the menu bar, select



to have access to the interface of “Frame Para. 1” or

“Frame Para. 2”:



Appendix 6 Automatic Limits Function

2	Frame Curve&Angle	F1/F2/230	3	Clothing Frame F	0/0/0/0
C06			G06		
1	Overframe by Step	No	3	Clothing Frame G	0/0/0/0
B03			G07		
2	High Frame-Shift Speed	16	3	Clothing Frame H	0/0/0/0
C15			G08		
2	Low Frame-Shift Speed	12	3	Clothing Frame I	0/0/0/0
C16			G09		
3	Speed When Overframe	16	3	Hat Frame J	0/0/0/0
D13			G10		
3	Clothing Frame A	0/0/0/0	2	Frame Select	No
G01			G11		
3	Clothing Frame B	0/0/0/0			
G02					
3	Clothing Frame C	0/0/0/0			
G03					
3	Clothing Frame D	0/0/0/0			
G04					
3	Clothing Frame E	0/0/0/0			
G05					
Normal Para Emb asst. Para Break detect Paral Break detect Para2 Frame Paral			Frame Para2 Main shaft Para Thread trimming Paral Thread trimming Para2 Sequin Paral		

There are four parameters in the Cloth Frame Type. “X Center” is the distance from the frame center to the X- limits coupler; “Y Center” is the distance between the frame center and the Y+ limits coupler; “X Frame Size” is the available embroidery range in X direction; “Y Frame Size” is the available embroidery range in Y direction.

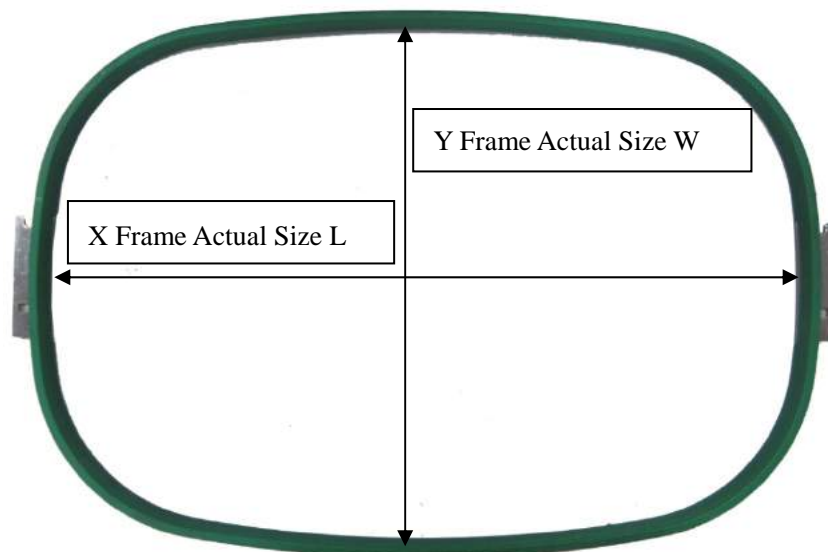



“X Frame Size” and “Y Frame Size” should be set according to the frames actually used. Attention: because usually the cloth frame is not the rectangle, this parameter value shall be set according to the available embroidery range of the frame in actual. We can take the picture at below as the reference:

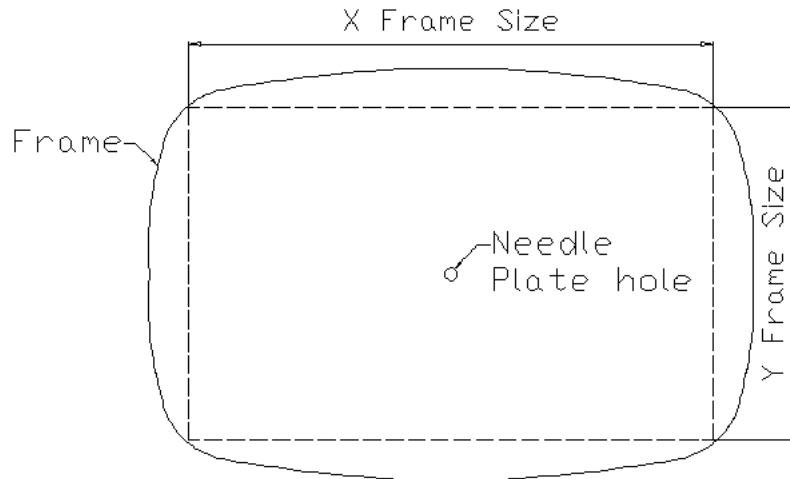

X/Y Center (X,Y) can be figured out from the calculation and measurement. We take the “Cloth Frame A” as example. The size of cloth frame A is 550×375, the embroidery area at 430×260. Therefore L=550, W=375.

Set the X/Y Center of the “Cloth Frame A” as 0, and set the X/Y Frame Size as the actual embroidery area 430/260.

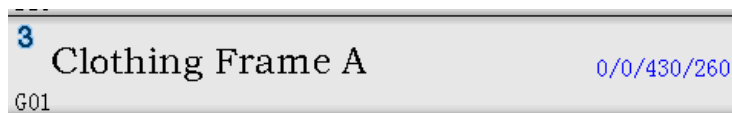

Set the “Frame Selection” as “Cloth Frame Type A”. The frame will move to the position (0, 0), which is the origin.

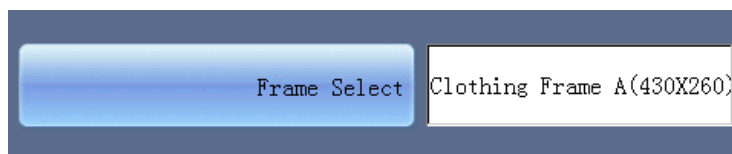

Measure the distance A (from needle plate hole to the right edge of frame) and distance B (from the needle plate hole to the front edge of frame).

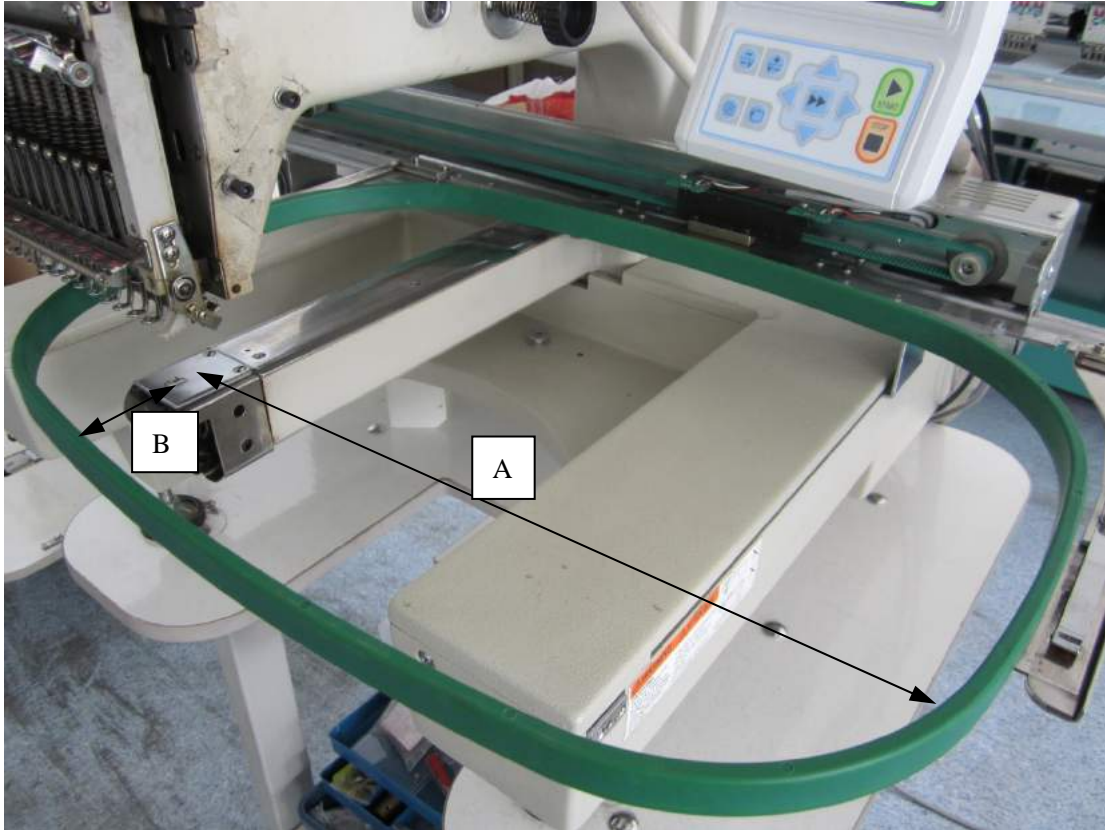

“X Center” $X = A - L / 2$;

“Y Center” $Y = W / 2 - B$;

Fill the X and Y into the form as the X/Y Center for Cloth Frame A.

<-1500, 1500>	Center X (mm)	140	X
<-1500, 1500>	Center Y (mm)	117	Y
<-1500, 1500>	X Size (mm)	430	
<-1500, 1500>	Y Size (mm)	260	

(3) Parameter Adjustment

Due to the error at measurement, the calculated coordinate may be not so accurate. Therefore, user needs to measure to make sure whether the distances from the needle plate hole to the four edges of frame are equal. If not, user needs to adjust the “X Center” and “Y Center” so as to make these distances become equal, as shown in below:

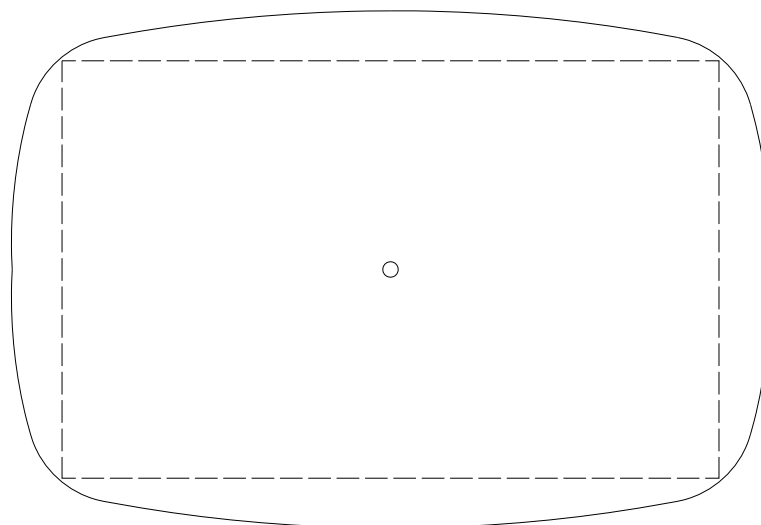

Synchronization Status

At present, in the controller, we have preset 9 kinds of cloth embroidery frame for user, which is in the parameter “Cloth Frame Type A/B/C/D/E/F/G/H/I”. These nine frame types can be set in “Frame Selection” within “Frame Parameter 2” when user needs replace the frame.

3. Method for Setting the Automatic Limits of Cap Embroidery

Because the frame for cap embroidery is round, we can not calculate the “X Center” as we do in cloth embroidery. The “X Center” for the Frame of Cap Embroidery should be measured as below:

Set the “Frame Selection” as NO.



Manually move the frame to align the needle plate hole and the Center of cap frame in X direction. Measure the Distance D (from frame edge to the X guide stand edge).



Set the “Cap Embroidery Type J” as “0/0/0/0”, then select “Cap Type J (0X0)” in “Frame Selection”. After the confirmation, the frame should be moved to the absolute origin.

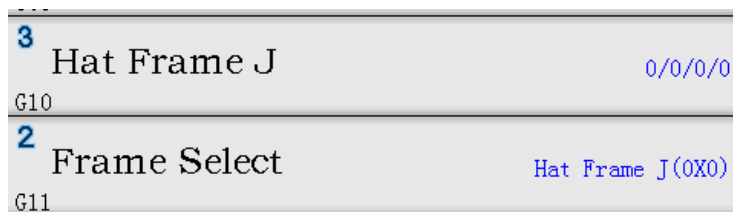

Then measure the Distance E (from frame edge to the X guide stand edge).



Cap Frame: “X Center” $X = D - E$

Let us calculate the “Y Center” Y.

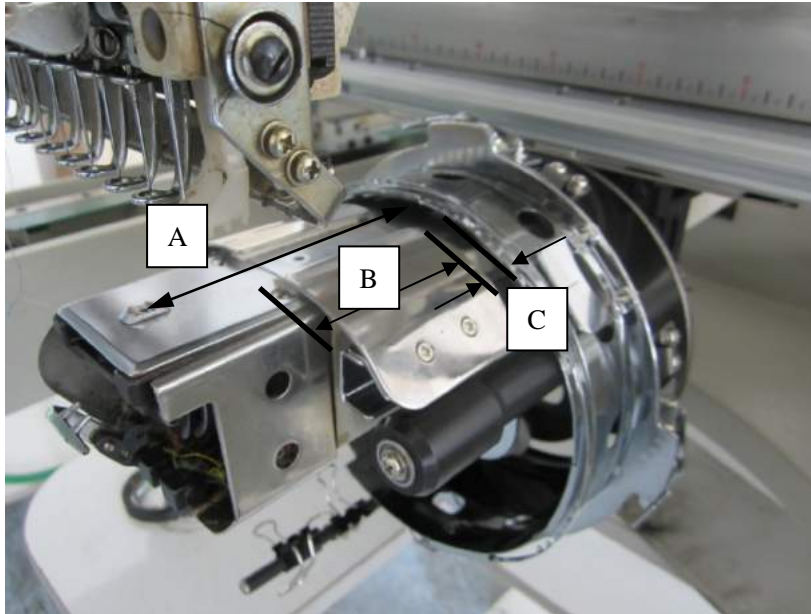

In the above picture, C is the preserved distance, which users can set according to their devices. B is the available range of cap frame for embroidery in the Y direction.

“Y Center” $Y = A - C - B / 2$ 。

Input the “X Center” X, “Y Center” Y and X/Y Embroidery Range for Cap Frame into the parameters of “Cap Emb. Type J”.

Note: “X Center” and “Y Center” can be adjusted manually, so that the error in measurement can be minimized.

4. Cancellation of Automatic Limits for Cloth Embroidery/ Cap Embroidery

Set the “N” in the “Frame Selection” at “Frame Para. 2”, so that the automatic limits function of cloth embroidery/ cap embroidery can be cancelled. At the same time, the software protection on the flat embroidery frame will be invalid as well.





5. Size of Frames for Cloth Embroidery (Unit: mm)

Cloth Embroidery Frame A:

Size: 550×375

Range: 430×260

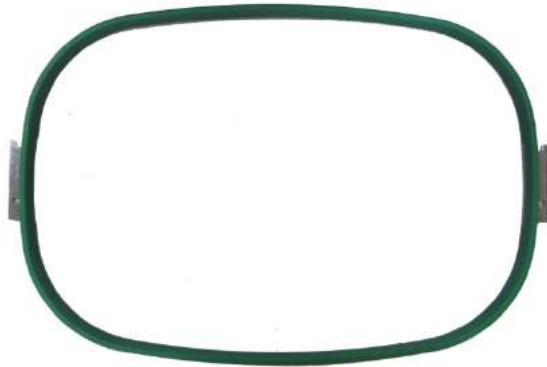

Cloth Embroidery Frame B:

Size: 290×290

Range: 230×230



Cloth Embroidery Frame C:

Size: 200

Range: 150



Cloth Embroidery Frame D:

Size: 150

Range: 100



Cloth Embroidery Frame E:

Size: 120

Range: 90



Cloth Embroidery Frame F:

Size: 90

Range: 40

